

**EverFlo™ Oxygen Concentrator**  
**EverFlo™ Q Oxygen Concentrator**

**Service & Technical Reference Manual**



**REVISION HISTORY**

<b>Revision</b>	<b>Description</b>	<b>Author</b>
06	Updated to include Field Communications Reformatted	K. Carter

- Chapter 1. INTRODUCTION.....5**
  - 1.1 EVERFLO OXYGEN CONCENTRATOR OVERVIEW ..... 5
  - 1.2 SERVICE NOTICE ..... 5
  - 1.3 SERVICE TRAINING..... 5
  - 1.4 SERVICE/TECHNICAL SUPPORT STATEMENT..... 5
- Chapter 2. WARNINGS & CAUTIONS.....6**
  - 2.1 WARNINGS ..... 6
  - 2.2 CAUTIONS ..... 7
- Chapter 3. SPECIFICATIONS & CLASSIFICATIONS .....8**
  - 3.1 SPECIFICATIONS..... 8
- Chapter 4. THEORY OF OPERATION .....10**
  - 4.1 PNEUMATIC OPERATION..... 10
  - 4.2 ELECTRICAL OPERATION..... 12
  - 4.3 PCA CONTROLLER OVERVIEW..... 12
- Chapter 5. SYSTEM SETUP .....14**
  - 5.1 INTRODUCTION ..... 14
  - 5.2 SYSTEM SETUP PROCEDURES..... 14
- Chapter 6. MAINTENANCE.....16**
  - 6.1 DEALER ROUTINE MAINTENANCE ..... 16
  - 6.2 EVERFLO OXYGEN CONCENTRATOR MAINTENANCE RECORD ..... 17
  - 6.3 SYSTEM VERIFICATION PROCEDURES ..... 18
- Chapter 7. TROUBLESHOOTING & ALARMS .....31**
  - 7.1 INTRODUCTION ..... 31
  - 7.2 INDICATORS & ALARMS..... 31
  - 7.3 TROUBLESHOOTING TABLE ..... 32
  - 7.4 SYSTEM PRESSURE TEST TABLE ..... 39
- Chapter 8. REPAIR & REPLACEMENT .....40**
  - 8.1 OVERVIEW ..... 40
  - 8.2 REPAIR KIT REFERENCE TABLE..... 41
  - 8.3 FILTER COVER REPLACEMENT..... 44
  - 8.4 INLET FILTER REPLACEMENT ..... 45
  - 8.5 REAR CABINET/POWER CORD REPLACEMENT..... 46
  - 8.6 O<sub>2</sub> QUICK COUPLER REPLACEMENT ..... 49

- 8.7 EVERFLO AND EVERFLO Q PRESSURE REGULATOR ASSEMBLY REPLACEMENT..... 50
- 8.8 EVERFLO ULTRAFILL COMPATIBLE PRESSURE REGULATOR ASSEMBLY REPLACEMENT ..... 52
- 8.9 MAIN PCA REPLACEMENT..... 55
- 8.10 SIEVE CANISTER ASSEMBLY REPLACEMENT ..... 59
- 8.11 VALVE SOLENOID REPLACEMENT ..... 63
- 8.12 COOLING FAN REPLACEMENT ..... 67
- 8.13 CAPACITOR REPLACEMENT ..... 69
- 8.14 COMPRESSOR REPLACEMENT ..... 70
- 8.15 MICRO-DISK FILTER & TUBING REPLACEMENT ..... 79
- 8.16 FLOW METER REPLACEMENT ..... 80
- 8.17 FRONT CABINET REPLACEMENT ..... 81
- 8.18 RETURNS / PACKAGING ..... 84
- 8.19 LABELS..... 88
- Chapter 9. TESTING ..... 90**
- 9.1 LONG LIFE FILTER TEST ..... 90
- 9.2 EVERFLO SYSTEM FINAL TEST ..... 90
- 9.3 EVERFLO TEST DATA SHEET ..... 93
- Chapter 10. TOOLS AND EQUIPMENT..... 94**
- 10.1 ACCEPTABLE TEST EQUIPMENT ..... 95
- Chapter 11. SERVICE SOFTWARE..... 96**
- 11.1 EVERFLO SERVICE TOOL..... 96

## Chapter 1. INTRODUCTION

### CAUTION

This section provides an introduction to the EverFlo Oxygen Concentrator as well as contact and service training information.

### 1.1 EVERFLO OXYGEN CONCENTRATOR OVERVIEW

The EverFlo Oxygen Concentrator produces concentrated oxygen from room air for delivery to a patient requiring low flow oxygen therapy. The oxygen from the air is concentrated using a molecular sieve and a pressure swing adsorption process. The EverFlo Oxygen Concentrator is not intended to be life supporting or life sustaining.

### 1.2 SERVICE NOTICE

The EverFlo Oxygen Concentrator is designed so that trained Service Technicians can perform repair and testing procedures. Only trained and qualified personnel should repair these products using authorized parts.

### 1.3 SERVICE TRAINING

Philips Respironics offers service training for EverFlo Oxygen Concentrators. Training includes complete disassembly of the device, troubleshooting subassemblies and components, repair and replacement of components, setup of test equipment, and necessary testing. For more information, contact the Respironics Customer Service department @ 1-800-345-6443.

### 1.4 SERVICE/TECHNICAL SUPPORT STATEMENT

For technical assistance, please contact Philips Respironics Service and Technical Support.



#### U.S.A. and Canada

Phone: 1-800-345-6443

Fax: 1-800-886-0245

#### International

Phone: 1-724-387-4000

Fax: 1-724-387-5012

## Chapter 2. WARNINGS & CAUTIONS

Warnings and cautions are used throughout this manual to identify possible safety hazards, conditions that may result in equipment or property damage, and important information that must be considered when performing service and testing procedures on the EverFlo Oxygen Concentrator. Please read this section carefully before servicing the EverFlo Oxygen Concentrator. Additional Warning and Cautions can be located in the EverFlo User Manual.

### **WARNING**

Warnings indicate the possibility of injury to people.

### **CAUTION**

Cautions indicate the possibility of damage to equipment.

## 2.1 WARNINGS

### **WARNINGS**

- For proper operation, your concentrator requires unobstructed ventilation. The ventilation ports are located at the top and bottom of the rear cabinet. Keep the device 6 to 12 (15 to 30 cm) inches away from walls that could impede adequate airflow to the device. Always make sure that these areas are not obstructed by items, which may impede ventilation. Do not place concentrator in a small closed space.
- Servicing of this device must be referred to an authorized and trained Respironics home care provider.
- Oxygen generated by this concentrator is supplemental and should not be considered life supporting or life sustaining. In certain circumstances, oxygen therapy can be hazardous; any user should seek medical advice prior to using this device.
- Oxygen vigorously accelerates combustion and should be kept away from heat or open flame. Not suitable for use in the presence of a flammable anesthetic mixture with air, with oxygen, or with nitrous oxide.
- Do not smoke or allow others to smoke or have open flames near the concentrator when it is in use.
- Do not use oil or grease on the concentrator or its components as these substances, when combined with oxygen, can greatly increase the potential for a fire hazard and personal injury.
- Do not use the concentrator if either the plug or power cord is damaged. Do not use extension cords or electrical adaptors.
- Do not attempt to clean the concentrator while it is plugged into an electrical outlet.

**WARNINGS**

- Avoid handling the molecular sieve material. Respironics recommends the return of the sieve canister assembly to Respironics for any service that involves sieve disposal.
- Use extreme caution when handling the compressor capacitor as it holds an electrical charge until it is properly discharged.
- Device operation above or outside of the voltage, LPM, temperature, humidity and/or altitude values specified may decrease oxygen concentration levels.
- If the EverFlo Oxygen Concentrator has been subjected to sub-freezing temperatures for an extended period, it should be allowed to warm up to the stated operating temperatures before power up. Failure to do so could result in improper performance and or alarm conditions until the device reaches normal operating temperatures.

**2.2 CAUTIONS****CAUTIONS**

**Chapter 3. SPECIFICATIONS & CLASSIFICATIONS**

**3.1 SPECIFICATIONS**

<b>Model Numbers</b>	<b>Voltage</b>	<b>Operational Power Frequency</b>	<b>Power Consumption</b>	<b>Oxygen Concentration Zero to Maximum Flow LPM</b>	<b>Sound Level</b>	<b>Weight</b>
1020000 1020001 1020002 1020003 1039362 1039363	120 VAC ± 10%	60 Hz	350 W At 120 VAC	90 - 95.5%	45 dBA typ	31 lbs (14 kg)
1020002BR 1020003BR 1039364 1039365	120 VAC ± 10%	60 Hz	350 W At 120 VAC	90 - 95.5%	43 dBA typ	31 lbs (14 kg)
1020014 1020015	120 VAC ± 10%	60 Hz	350 W At 120 VAC	90 - 95.5%	<40 dBA typ	31 lbs (14 kg)
1020006 1020009 1020010 1020011 1020012 1020016 1020017 1020020 1039366 1039370	230 VAC ± 10%	50 Hz	<300 W At 230 VAC	90 - 95.5%	43 dBA typ	33 lbs (15 kg)
1020008 1039368 1104000	230 VAC ± 10%	50 Hz	<300 W At 230 VAC	87 - 95.5%	43 dBA typ	33 lbs (15 kg)
1020007 1039367	230 VAC ± 10%	50 Hz	<300 W At 230 VAC	87 - 95.5%	<40 dBA typ	33 lbs (15 kg)
1125558	230 VAC ± 10%	50 Hz	<300 W At 230 VAC	90 - 95.5%	<40 dBA typ	33 lbs (15 kg)
1020004 1020005	220 VAC ± 10%	60 Hz	320 W At 220 VAC	90 - 95.5%	45 dBA typ	33 lbs (15 kg)
1020013	220 VAC ± 10%	60 Hz	<300 W At 220 VAC	90 - 95.5%	43 dBA typ	33 lbs (15 kg)
1102443	230 VAC ± 10%	60 Hz	<300 W At 230 VAC	90 - 95.5%	43 dBA typ	33 lbs (15 kg)



<b>All Models</b>	
Dimensions	22.8" (58 cm) x 15" (38 cm) x 9.5" (24 cm) (H x W x D)
Oxygen Purity Alarms	Low Oxygen at 82% purity (For OPI models only), Very Low Oxygen at < 70%
Operating Temperature	55° F to 90° F (13° C to 32° C)
Storage and Transport Temperature	29° F to 160° F (-34° C to 71° C)
Relative Humidity	15 to 95%, noncondensing
Outlet Pressure	5 to 7 psi (0.34 to 0.48 Bar)
Operating Altitude	0 to 7,500 ft (0 to 2,286 m) meets specifications 7,500 to 13,123 ft (2286 to 4000 m) not specified, exceeds specified operating altitude
Maximum Flow at 0 & 7 kPa Outlet Pressure	5 LPM (3 LPM During trans fill operation)
Pressure Relief Valve	49 to 55 psi (338 to 378 kPa)
<p>Each EverFlo unit is measured in the factory with an Oxygen Analyzer that measures oxygen concentration with an accuracy specification of +/- .1 %. When using an Oxygen Analyzer with an accuracy specification of +/- 2 % to test the Oxygen Concentration for an EverFlo Oxygen Concentrator, you may receive inaccurate readings below the acceptable pass criteria for the device. This 2% offset should be taken in to consideration when determining if the EverFlo is functioning properly. A more accurate Oxygen Analyzer may also be used for a more precise measurement of the oxygen purity. As an example, a unit could be measured in the factory with the +/- 1% Oxygen Analyzer to measure 91.1%. If this same unit is then measured with a +/- 2% Oxygen Analyzer, the reading could display a result of 89.1%. With the +/- 2% Oxygen Analyzer, it may inaccurately look like the unit falls below the 90-95.5% specification, when in fact the unit is within specification.</p>	

Refer to User Manual (1041063) for classification, standards compliance, and EMC requirements.

## Chapter 4. THEORY OF OPERATION

This section describes the theory of operation for the EverFlo Oxygen Concentrator.

### 4.1 PNEUMATIC OPERATION

Refer to Figure 4-1 while reading the following discussion.

The room air is drawn into the unit through the air inlet filter by the compressor. The compressed air is routed to the sieve beds through an electronically controlled Solenoid Valve Assembly. The Solenoid Valve alternates the airflow to a pair of sieve beds that allows Oxygen production. The Solenoid Valve Assembly also alternates the flow through the sieve beds to allow purging of the Nitrogen molecules from the sieve beds.

At startup, the valve/solenoid is de-energized allowing compressed air to flow through both sieve beds until the pressure sensor builds up to switching pressure. At switching pressure, a 12-volt signal is received at the valve/solenoid closing off the input and allowing the compressed air to cycle through one of the sieve beds. As the air is cycled through one of the sieve beds, the molecular sieve material traps the Nitrogen molecules from the air and allows the Oxygen enriched air to flow through the sieve bed.

At 5 liters of flow, approximately 1/3 of the Oxygen enriched air enters the product tank and the other 2/3 of the Oxygen enriched air is passed through an orifice in the sieve bed to purge the trapped Nitrogen molecules from the sieve bed, allowing the sieve material to be ready for Oxygen production during the next cycle.

The concentrated Oxygen is stored in the product tank. The product tank is continuously filled with concentrated Oxygen and the output from the product tank is regulated at 5.5 psig nominal. The product tank pressure is continuously monitored using a pressure sensor. The stored Oxygen is delivered to the patient through a pressure regulator, an externally adjustable flow meter and a microbial filter.

#### **NOTE**

In the beginning, the 230V units, had an orifice built into the purge valve. The electronically controlled purge valve controls the Oxygen flow timing from one sieve bed to the other based on the flow meter setting.

Figure 4-1: Pneumatic Block Diagram (Non-O2 Piloted)

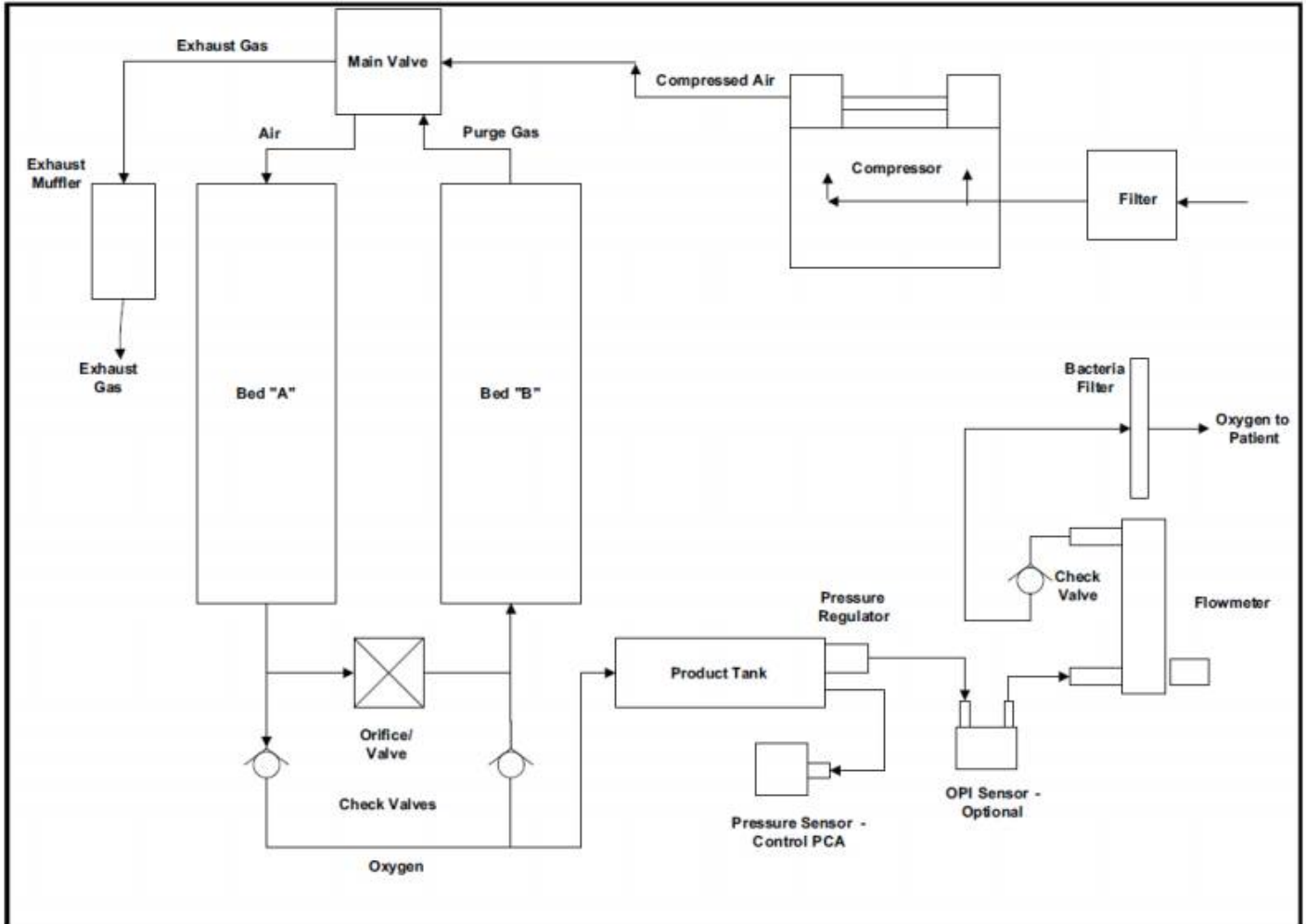

## 4.2 ELECTRICAL OPERATION

The EverFlo Concentrator is a medical device, which produces concentrated oxygen from room air for delivery to a patient. It uses a molecular sieve and a pressure swing adsorption process to concentrate oxygen from air. The device consists of filters, a compressor, a sieve canister module, a set of valves, a microprocessor-based electronic controller PCA, a flow meter and a cooling fan – all contained within a plastic enclosure.

The EverFlo Embedded Software—via the microprocessor contained on the PCA Controller—controls the sieve valves used to generate the oxygen, measures/monitors the pressure & oxygen levels, drives the Elapsed Time counter (Hour meter), reports exception conditions to the User via visual and audible indicators and provides diagnostic information to a Host computer via an RS232 communications interface.

## 4.3 PCA CONTROLLER OVERVIEW

All the electric / electronic functions of the EverFlo Concentrator reside on the PCA Controller. A block diagram of the PCA controller is provided in Figure A. The reader is urged to continually refer to this diagram when reading the remaining sections of this document.

The PCA controller can be sub-divided into 2 major sections:

1. Power distribution and DC voltage generation.
2. Monitoring / Control / User Interface.

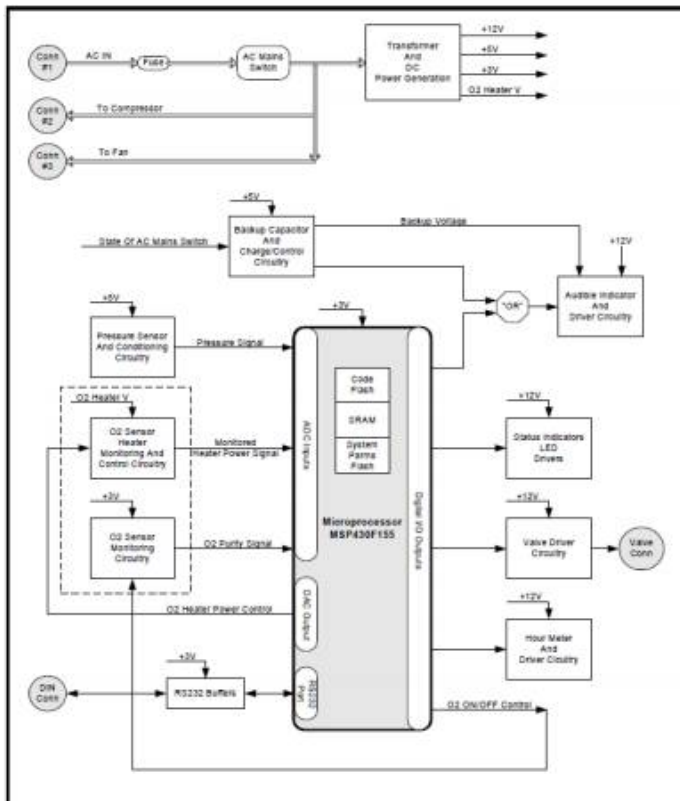

**Figure 4-2: EverFlo PCA Controller Block Diagram**

### **4.3.1 POWER**

The AC mains power, via the line cord, is brought onto the PCA and the “switched” AC is distributed to the Compressor, the Cooling Fan and to the AC to DC conversion module. The DC voltages that are generated are used to power the remaining circuitry.

The PCA contains a 1 Farad “super capacitor” which is used to sound the Audible Indicator when the AC mains power is absent AND the mains switch is in the ON position. The purpose is to alert the User to the fact that there has been a loss of AC mains power (that is, an AC mains power failure, a plug removal, a blown fuse). The circuitry functions as follows:

1. During normal operation, the capacitor is energized (charged) using the +5 VDC. The capacitor reaches full charge after approximately ½ hour of system on-time.
2. The mains switch has a 2nd set of contacts that are used to determine whether the switch is open or closed. If the switch is closed (in the ON position) and the microprocessor is not functional (no DC power), then the backup circuitry is such that it will turn on the Audible Indicator, using the “super cap” as its energy source.

The “super cap” is capable of sounding the Audible Indicator for a period of greater than 8 minutes, given that it is fully charged.

### **4.3.2 MICROPROCESSOR AND ASSOCIATED CIRCUITRY**

The remainder of the PCA controller electronics is centered around the MSP430F155 microprocessor. The microprocessor is the only processing element contained in the EverFlo concentrator. In addition to the microprocessor, the “remaining circuitry” consists of sensors, LEDs, a piezo Audible Indicator, amplifiers / signal conditioners, communication buffers and discrete components.

The embedded software, in conjunction with the microprocessor and its associated hardware, is used to control the sieve valves, measure/monitor the pressure & oxygen levels, control the oxygen sensor, drive the Hour meter, reports exception conditions to the User via visual and audible indicators and provide diagnostic information to a Host computer via an RS232 communications interface.

## Chapter 5. SYSTEM SETUP

### NOTE

### 5.1 INTRODUCTION

This section provides information regarding setup and operation of the EverFlo Oxygen Concentrator as needed for servicing, repairing, and testing the device.

### 5.2 SYSTEM SETUP PROCEDURES

1. Select a location that allows the concentrator to draw in room air without being restricted. Make sure that the device is at least 6 to 12 inches (15 to 30 cm) away from walls, furniture, and especially curtains that could impede adequate airflow to the device. Do not place the device near any heat source.
2. Plug the EverFlo Oxygen Concentrator into an electrical outlet.
3. If you are NOT using a humidifier, connect the cannula to the EverFlo Oxygen Outlet Port, as shown below. Proceed to step 4.



4. If you are using a humidifier follow these steps:
  - a. Open the filter door on the back of the device.
  - b. Remove the humidifier connector tube from the back of the filter door and replace the filter door.
  - c. Fill the humidifier with water following the manufacturer's instructions.
  - d. Mount the filled humidifier on the top of the EverFlo device inside the velcro strap.
  - e. Tighten the velcro strap around the bottle and secure it so it is held firmly in place.
  - f. Connect the humidifier connector tube (that you retrieved from the filter door) to the Oxygen Outlet Port.
  - g. Connect the other end of the humidifier connector tube to the top of the humidifier with the elbow in the tubing facing the front.
  - h. Connect your cannula to the humidifier bottle according to the humidifier bottle manufacturer's specifications.

5. Press the power switch to the On [I] position. Initially, all the LEDs will illuminate and the audible alert will sound for a few seconds. After that time, only the green LED should remain lit. You can begin breathing from the device immediately even though it typically takes 10 minutes to reach oxygen purity specifications. The device normally takes 10 minutes to reach oxygen purity specifications.
6. Adjust the flow to the proper setting by turning the knob on the top of the flow meter until the ball is centered on the line marking the specific flow rate.
7. Be sure oxygen is flowing through the cannula. If it is not, refer to the Troubleshooting section of this manual.
8. When you are not using the oxygen concentrator, press the power switch to the Off [O] position.

## **Chapter 6. MAINTENANCE**

### **6.1 DEALER ROUTINE MAINTENANCE**

This section describes scheduled and routine maintenance procedures. Normal routine maintenance involves periodic checking, cleaning, and or replacing the following items as necessary:

- Inlet Filter
- Micro-Disk Filter
- Cabinet cleaning
- LPM flow setting to the prescribed level
- Oxygen concentration level

Routine maintenance is very important in prolonging dependability and in reducing costly repairs. Long-term maintenance and regular checking of the filters helps assure the efficient operation of the unit.

#### **6.1.1 FILTERS**

Respironics recommends checking and replacing the Inlet Filter every two (2) years. Respironics also recommends checking and replacing the Micro-Disk filter as necessary.

#### **6.1.2 CABINET**

Commensurate with hospital or homecare policies, Respironics recommends cleaning the cabinet and inspecting for damage as necessary. Ensure that the small holes on the Inlet Filter door are unobstructed. Refer to the Tools and Equipment section for approved cleaning solution.

#### **6.1.3 FLOW SETTING**

Commensurate with hospital or homecare policies, Respironics recommends verifying the patient flow setting as necessary.

#### **6.1.4 OXYGEN CONCENTRATION VERIFICATION**

Commensurate with hospital or homecare policies, Respironics recommends verifying the oxygen concentration level per homecare provider's policies as necessary. Refer to the Testing section for more detailed instructions on how to check the oxygen concentration level.

#### **6.1.5 COMPRESSOR**

Respironics does not require routine maintenance or recommend field service of the EverFlo Oxygen Concentrator compressor. The compressor may require replacement when:

- The system pressure is not within specifications and there are no leaks detected.
- The compressor bearings have worn to a point that make the compressor noticeably louder.

#### **6.1.6 HUMIDIFIER CONNECTOR TUBE AND CONNECTOR**

Commensurate with hospital or homecare policies, Respironics recommends disinfecting the tube and connector using 70% isopropyl alcohol.



**6.2 EVERFLO OXYGEN CONCENTRATOR MAINTENANCE RECORD**

MODEL NUMBER	SERIAL NUMBER



DATE/HOURS/LPM <i>(Record at Each Check)</i>	FILTERS <i>(Clean &amp; Replace as Necessary)</i>		OXYGEN CONCENTRATION <i>(Check Level)</i>
	<i>Inlet</i>	<i>Micro-Disk</i>	

CABINET <i>(Clean and Inspect as Necessary)</i>	FLOW SETTING <i>(Check Setting)</i>

## **6.3 SYSTEM VERIFICATION PROCEDURES**

The following procedures may be performed at any time to ensure that the EverFlo Concentrator is functioning properly.

### **6.3.1 SYSTEM SELF TEST AND START UP TEST**

1. Connect the power cord to the proper power source.
2. Turn on the unit by moving the power switch to the ON (I) position and verify the following:
  - All LEDs light up and the audible alarm sounds for two seconds.
  - The unit starts to run.
  - The red and yellow LED lights go off and the audible alarm stops.
  - The green LED stays on.

### **6.3.2 POWER LOSS ALARM TEST**

1. Test the power loss alarm as follows:
  - a. Connect the device to a proper power source.
  - a. Let the device warm up for two minutes to charge the capacitor.
  - b. Disconnect the device from the power source and move the power switch to the On (I) position and verify an audible alarm sounds continuously.
  - c. The alarm should have sufficient power to sound for 10 minutes. Verify that the EverFlo Device alarms.
  - d. If the audible alarm does not sound, replace the Main PCA.

### **6.3.3 OUTLET/REGULATED PRESSURE TEST**

1. Power up the unit and allow it to run for at least two minutes to stabilize.
2. Set the flow meter to 5 LPM (1 LPM for units equipped with pediatric flowmeters).

**NOTE**

3. Connect the pressure gauge from the tool kit to the outlet barb. The flow ball should drop to 0.0 LPM.

**NOTE**

4. If the outlet pressure does not fall between 5.0 and 7.0 psig, perform steps 5 through 14. If the pressure does fall between 5.0 and 7.0 psig, remove pressure gauge, the test is now complete.
5. Turn the unit off.
6. Remove the pressure gauge from the outlet barb.
7. Remove the front and rear cabinets.

8. Insert a "T" from the tool kit in between the regulator and the clear oxygen tubing and connect the pressure gauge.



9. Turn the device on and set the flow meter to 5 LPM (1 LPM for units equipped with pediatric flow meters).
10. With the gauge held in a vertical position, verify that the regulated pressure is at  $5.5 \pm 0.25$  psig.
11. If the regulated pressure needs adjusted, place a 3/32" Allen wrench in the adjusting screw on the end of the regulator.

### NOTE

12. Disconnect the pressure gauge and "T" fitting.
13. Reconnect the clear oxygen tubing to the pressure regulator.
14. Install the front and rear cabinets.

**6.3.4 SYSTEM PRESSURE TEST**

The system pressure test is used to verify the proper operation of the EverFlo Compressor and Sieve Canister Assemblies.

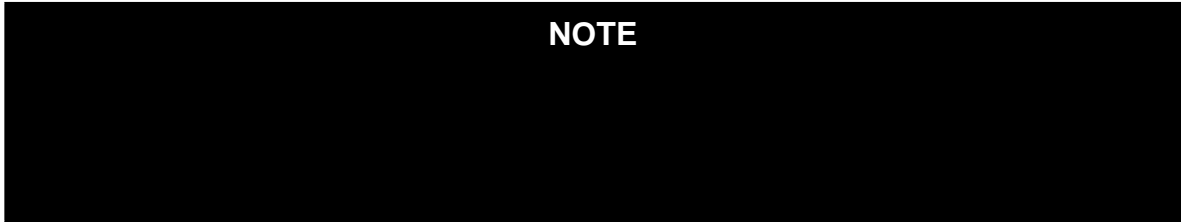

1. Run the unit with the front and rear cabinets in place for a minimum of ten minutes.
2. Set the flow to 5 LPM (1 LPM for units equipped with pediatric flowmeters).
3. Turn off the Everflo Oxygen Concentrator.
4. Remove the front and rear cabinets from the unit.
5. Disconnect the yellow pressure tubing from the fitting on the PCA. Using the pressure gauge, "T" fitting, and pressure tubing supplied with the Concentrator tool kit, connect to the Pressure Regulator as shown below.

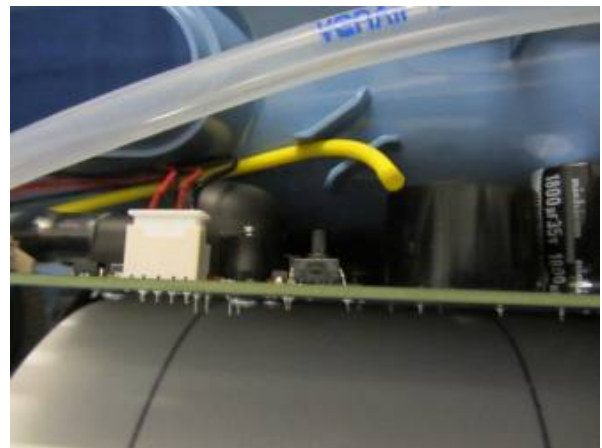

6. Turn the unit on and allow the unit to cycle for at least two (2) minutes to stabilize.
7. Hold the pressure gauge in a vertical position.
8. Verify pressures against the table below. This table is a reference guideline for system pressures and troubleshooting. If a value is measured outside of these ranges, it may not mean the unit has a fault. If the Outlet Pressure and Outlet Oxygen values are within tolerances, and the unit is not alarming, the unit should be considered acceptable.

EverFlo Model	Normal Pressure for units equipped with Purge Valves		Normal Pressure for units without Purge Valves	
	Min	Max	Min	Max
1020000 1020001 1020002 1020003 1020002BR 1020003BR 1039362 1039363	NA	NA	15	27
1020004 1020005	NA	NA	NA	NA
1020006 1020009 1020010 1020011 1020012 1020016 1020017 1039366 1039368 1039370	16	24	14	25
1020007 1020008 1039367	12	22	12	23
1020013	NA	NA	11	22
1020014 1020015 1039364 1039365	NA	NA	14	24

9. Record the peak pressure for four cycles.

CYCLE 1	CYCLE 2	CYCLE 3	CYCLE 4

10. Confirm that all peaks are within one (1) psig of each other.

**NOTE**

11. Turn off the EverFlo Concentrator and disconnect the pressure gauge, "T" fitting, and tubing. Reconnect the yellow tubing to the Pressure Regulator Adaptor located on the top of the Sieve Canister Assembly.
12. Install the front and rear cabinets.

**6.3.5 OXYGEN OUTPUT TEST**

1. Power up the concentrator and allow it to run for a minimum of 15 minutes.
2. Connect a calibrated oxygen analyzer to the outlet fitting of the concentrator.



3. Set the flow to 5 LPM (1 LPM for units equipped with pediatric flowmeters).
4. Verify the oxygen reading is as follows:

MODEL NUMBER	OXYGEN PURITY
1020000, 1020001, 1020002, 1020003, 1020002BR, 1020003BR 1020004, 1020005, 1020006, 1020009, 1020010, 1020011, 1020012, 1020013, 1020014, 1020015, 1020016, 1020017, 1039362, 1039363 1039364, 1039365 1039366, 1039368, 1039370	$\geq 90\%$
1020007, 1020008, 1039367	$\geq 87\%$

**6.3.6 MAIN PCA OXYGEN VERIFICATION (OPI UNITS ONLY)**

This procedure verifies that the Main PCA is operating properly.

1. Plug the unit into a power outlet.
2. Turn the device on, set the flow to 5.0 LPM, and let it run for 10 minutes.
3. If either the yellow or red LED illuminates after 10 minutes, perform the oxygen output test with a calibrated oxygen analyzer. If the red LED illuminates, the audible alarm should also sound at the same time.

**NOTE**





If the device is alarming and the oxygen concentration is measured at 82% or higher, check the device for leaks. If no leaks are found then replace the Main PCA.





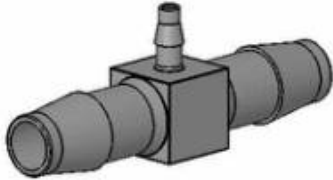

**6.3.7 COMPRESSOR TEST**

This procedure verifies if the Compressor is working properly.



**EQUIPMENT REQUIRED FOR OPTION 1**

Item	Reference Part No.	Description	Picture
1	McMaster-Carr: Qty 1 of Part #: 5121K851	White Polypropylene Barbed Tube Fitting Reducing Tee for 3/8" X 1/8" X 3/8" Tube ID	
2	McMaster-Carr: Qty 1 of Part #: 7781K33	Compact Plastic Needle Valve 3/8" Barb X 3/8" Barb Connections	
3	McMaster-Carr: Qty of 1 of Part #: 4089K13	Multipurpose Gauge +/-2% Mid-Scale Accuracy 2" Dial, 1/4" NPT Male Bottom, 0 - 60 PSI	
4	McMaster-Carr: Qty of 1 of Part #: 5439K19	High Pressure Tubing, 1/8" ID, 3/8" OD, 1/8" Wall	
5	McMaster-Carr: Qty 1 of Part #: 2974K278 (Same as 5463K653)	Durable Nylon Single-Barbed Tube Fitting Reducing Coupling for 1" X 1/2" Tube ID White	

Item	Reference Part No.	Description	Picture
6		Hose Clamp, Qty 5 Clamping range of 1/4" to 5/8"	
7		18" Patient Tubing, Qty 1	
8		TSI Flow Meter, Qty 1	
9		High-Pressure Tygothane Polyurethane Tubing Clear, 3/8" ID, 1/2" OD, 1/8" Wall. 10'L	
10		FDA White Nylon Single Barbed Tube Fitting Adapter for 1/8" Tube ID X 1/4" FNPT	
11		Stopwatch	

**EQUIPMENT REQUIRED FOR OPTION 2**

Items 1-4, 6, 9, and 10 as detailed above with the addition of the following items:

ID	Reference Part No.	Description	Picture
1		Male Tube Adapter 1/8" NPT x 3/8" Barb, McMaster-Carr: Part # 5372K116	
2		Flow Meter, Dwyer Instruments Part # RMA-25	

**ASSEMBLY INSTRUCTIONS FOR EQUIPMENT OPTION 1**

1. Connect the compressor blue outlet tube to Barbed Tube Fitting Reducing Tee (#1) and secure with a hose clamp (#6).
2. Thread the Barbed Tubing Fitting Adapter (#10) to the gauge (#3) using Teflon tape.
3. Connect the Tubing Fitting Adapter (#10) to the Reducing Tee (#1) using the High Pressure Tubing (#4).
4. Install the High Pressure Clear Tubing (#9) to the Reducing Tee (#1) and the Needle Valve (#2) and secure with hose clamps (#6).
5. Install the High Pressure Clear Tubing (#9) to the Needle Valve (#2) and the Single Barbed Tube Fitting (#5) and secure with hose clamps (#6).
6. Install the 18" Patient Tubing (#7) to the Single Barbed Tube Fitting (#5) and the TSI Flow Meter (#8).
7. Install the power adapter to the TSI Flow Meter (#8) and plug into a 120 VAC/60 Hz outlet.

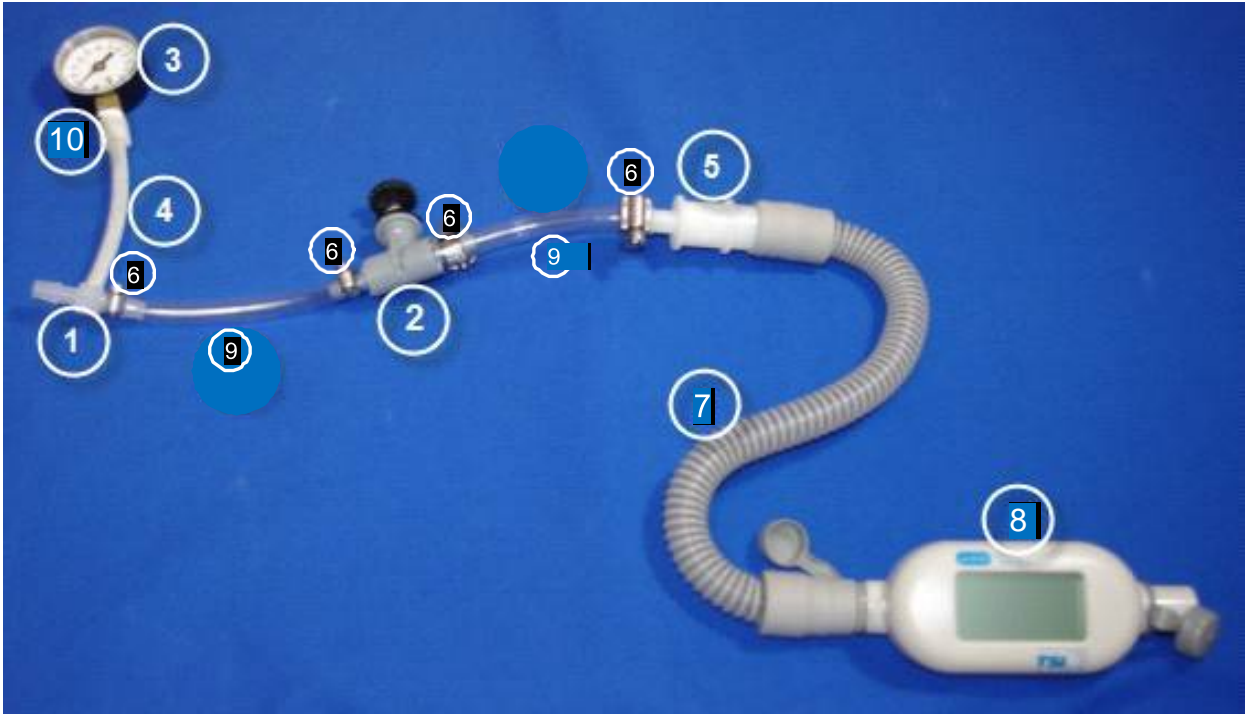

**ASSEMBLY INSTRUCTIONS FOR EQUIPMENT OPTION 2**

1. Connect the compressor blue outlet tube to Barbed Tube Fitting Reducing Tee (#1) and secure with a hose clamp (#6).
2. Thread the Barbed Tubing Fitting Adapter (#10) to the gauge (3) using Teflon tape.
3. Connect the Tubing Fitting Adapter (#10) to the Reducing Tee (#1) using the High Pressure Tubing (#4).
4. Install the High Pressure Clear Tubing (#9) to the Reducing Tee (#1) and the Needle Valve (#2) and secure with hose clamps (#6).
5. Install the High Pressure Clear Tubing (#9) to the Needle Valve (#2)
6. Install the 1/8" Male Tube Adapter (#12) to the Flow Meter (#13) using Teflon tape.
7. Install the High Pressure Clear Tubing (#9) to the 3/8" Male Tube Adapter (#12) and secure with a hose clamp (#6).

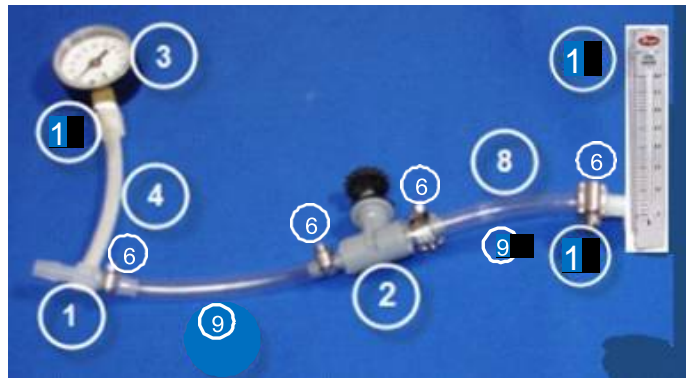

**ASSEMBLY INSTRUCTIONS FOR EQUIPMENT OPTION 3**

Option 3 is only available in SCMS (equipment not shown above).

1. Attach the TSI flow meter to the inlet filter.
2. Attach the grommet to the inlet adapter.
3. Inset the pipe nipple into a length of hose. (@ 7" in length)
4. Attach the hose to the Compact Plastic Needle Valve 3/8" Barb X 3/8" Barb Connections.
5. Join a short length of hose to the white polypropylene barbed tube.
6. Connect the pressure gage to the tee fitting on the barbed tube.
7. Attach a length of blue hose (30" in length) from the barb fitting to a brass fitting.  
This is the test end of the device for testing the compressors for flow and pressure.
8. Insert an inline muffler to help collect any sieve material in the test line.
9. Use clamps to secure the fittings together.

**PROCEDURE**

1. Follow the procedures detailed in the EverFlo Service Manual for the removal of the following components:
  - a. Filter Cover
  - b. Inlet Filter
  - c. Rear Cabinet

2. Remove the blue hose running from the Compressor to the Sieve Canister Assembly by carefully cutting the one-eared clamp.
3. Connect the Compressor blue outlet tube to the Test Fixture's Barbed Tube Fitting Reducing Tee.
4. Install the Inlet Filter to the Compressor's Inlet Boot.
5. If using Test Fixture Option 1, turn ON the flow meter.
6. Ensure is Compact Plastic Needle Valve is fully open.
7. Turn ON the EverFlo power switch.
8. Start the stopwatch.
9. Adjust Compact Plastic Needle Valve to achieve 20 psi pressure. (turning clockwise to increase pressure and turning counter-clockwise to decrease pressure)
10. When time reaches 1 minute, observe and record LPM reading from Flow Meter.
11. Stop the stopwatch.
12. A reading  $\geq 69$  LPM indicates a "PASS" for the 0.44 compressor, a reading  $< 69$  LPM indicates a "FAIL".
13. A reading  $\geq 63$  LPM indicates a "PASS" for the 0.38 compressor, a reading of  $< 63$  LPM indicates a "FAIL"
14. If the Compressor failed, replace the compressor as per the Service Manual Compressor Replacement instruction.
15. If the Compressor passed, continue to troubleshoot as per the System Verification Procedures in the Service Manual.

<b>Compressor Table</b>	
EVERFLO .38 COMPRESSOR-120V (MODEL 1098014 OR 1122381)	$\leq 63.0$ LPM indicates a "FAIL"
EverFlo Compressor-120V .44 (MODEL 1098014 OR 1122381)	$\leq 69.0$ LPM indicates a "FAIL".
PRI Compressor model 1082141 (115, 60Hz and .38 stroke)	$\leq 56.0$ LPM indicates a "FAIL".
PRI Compressor model 1082142 (115, 60Hz and .44 stroke)	$\leq 65.0$ LPM indicates a "FAIL".
GSE compressor (115, 60Hz and .45 stroke)	$\leq 68.0$ LPM indicates a "FAIL".

## Chapter 7. TROUBLESHOOTING & ALARMS

### 7.1 INTRODUCTION

This section provides service technicians with a troubleshooting table to determine which component(s) is any, must be replaced.

### 7.2 INDICATORS & ALARMS

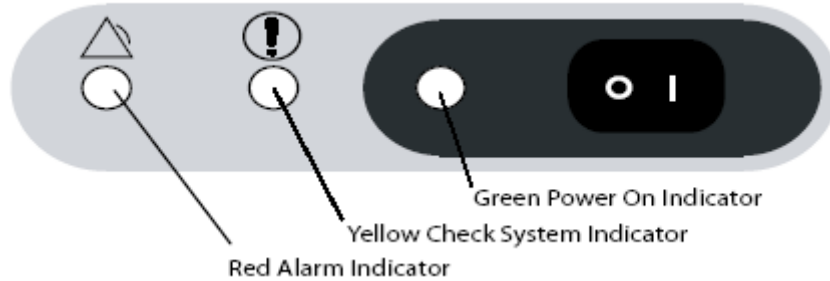

COLORED LED	POSSIBLE CAUSE
Yellow LED is blinking. The Red LED is off and the Audible Alarm is beeping periodically.	The device has detected a high oxygen flow condition.
Green LED illuminates continuously. The other LEDs are off and the Audible Alarm is silent.	The device is turned on and working properly.
The Audible Alarm is sounding continuously. None of the LEDs are illuminated.	The device is turned on but is not operating. Often this indicates that the device is not plugged in or there is a power failure.
The Audible Alarm is sounding continuously and all 3 LEDs are illuminated.	The device had detected a system malfunction.
Yellow LED illuminates continuously, the Red LED is blinking and the Audible alarm is beeping periodically.	The device has detected an impeded oxygen flow condition.
Red LED illuminates continuously and the Audible Alarm is beeping continuously.	The device has detected a system malfunction.
Yellow LED illuminates continuously. The Red LED is off and the Audible Alarm is silent.	The device has detected a low oxygen condition. (For OPI units only.)



**7.3 TROUBLESHOOTING TABLE**

<b>SYMPTOM</b>	<b>CAUSE</b>	<b>VERIFICATION</b>	<b>CORRECTIVE ACTION</b>
<ul style="list-style-type: none"> <li>• Low pressure</li> </ul>	<p><b>Canister to Compressor tubing failure</b></p> <p><b>Compressor failure</b></p> <p><b>Valve Solenoid failure</b></p> <p><b>Sieve Canister leaking</b></p>	<ul style="list-style-type: none"> <li>• Verify there are no leaks</li> <li>• Verify the tubing between the canister and Compressor is connected</li> <li>• Verify the tubing is not kinked or pinched</li> <li>• Verify there are no leaks in the hose from Compressor to Sieve Canister</li> <li>• Verify the Compressor is operating correctly</li> <li>• Verify the Valve Solenoid is working</li> <li>• Verify wiring harness from the Valve Solenoid to Main PCA are connected</li> <li>• Verify there are no leaks in Sieve Canister</li> </ul>	<ul style="list-style-type: none"> <li>• Repair leaks in tubing and hoses</li> <li>• Reconnect or replace the tubing</li> <li>• Reposition the tubing</li> <li>• Replace clamps or replace hose</li> <li>• Replace the Compressor</li> <li>• Replace the Valve Body</li> <li>• Reconnect the wiring harnesses and retest</li> <li>• If problem continues, install old valve body and new pilot valves</li> <li>• Replace the Sieve Canister Assembly</li> </ul>





<b>SYMPTOM</b>	<b>CAUSE</b>	<b>VERIFICATION</b>	<b>CORRECTIVE ACTION</b>
<ul style="list-style-type: none"> <li>• Fluctuations in oxygen pressure</li> <li>• Fluctuation in flow ball</li> </ul>	<p><b>Pressure Regulator failure</b></p> <p><b>Valve Solenoid failure</b></p>	<ul style="list-style-type: none"> <li>• Verify the flow from regulator is correct</li> <li>• Perform Outlet / Regulated Pressure Test</li> <li>• Verify the Valve Solenoid is working properly</li> <li>• Verify the valve wiring harness is connected at the Main PCA</li> </ul>	<ul style="list-style-type: none"> <li>• Replace the regulator</li> <li>• Replace the Valve Body</li> <li>• Reconnect the wiring harnesses and retest</li> <li>• If problem continues, install old valve body and new pilot</li> </ul>
<ul style="list-style-type: none"> <li>• Unit will not turn on</li> </ul>	<p><b>No power to the unit</b></p>	<ul style="list-style-type: none"> <li>• Verify the power cord is connected to the wall outlet</li> <li>• Verify there is power in the wall outlet</li> <li>• Verify if the outlet is connected to a light switch and the switch is in the ON position</li> </ul>	<ul style="list-style-type: none"> <li>• Connect the power cord to the wall outlet</li> <li>• Check the household fuse or circuit breaker</li> <li>• Move the power switch to the ON position</li> </ul>

SYMPTOM	CAUSE	VERIFICATION	CORRECTIVE ACTION
<ul style="list-style-type: none"> <li>LED failure</li> </ul>	<p><b>No power to LED's</b></p>	<ul style="list-style-type: none"> <li>Verify the power cord is plugged in</li> <li>Verify power in wall outlet</li> <li>Verify that all wiring harnesses are connected</li> <li>Verify the Main PCA is not damaged</li> </ul>	<ul style="list-style-type: none"> <li>Connect the power cord to AC power source</li> <li>Check the household fuse or circuit breaker</li> <li>Connect all wiring harnesses</li> <li>Replace the Main PCA</li> </ul>
<ul style="list-style-type: none"> <li>Unit is inoperable</li> </ul>	<p><b>Main PCA failure</b></p>	<ul style="list-style-type: none"> <li>Verify the wiring harnesses are connected</li> <li>Verify the wiring harness is not damaged</li> <li>Verify the condition of the fuse on PCA</li> <li>Verify the condition of the Power Cord</li> </ul>	<ul style="list-style-type: none"> <li>Connect the wiring harnesses</li> <li>Check the wiring harnesses for continuity</li> <li>Test the fuse for electrical continuity</li> <li>Verify the Power Cord continuity</li> <li>Replace Power Cord</li> <li>Replace the Main PCA</li> </ul>
<ul style="list-style-type: none"> <li>Start-up alarms inoperable</li> </ul>	<p><b>Piezoelectric speaker failure</b></p>	<ul style="list-style-type: none"> <li>Verify the solder joints on the piezoelectric speaker</li> </ul>	<ul style="list-style-type: none"> <li>Replace the Main PCA</li> </ul>

<b>SYMPTOM</b>	<b>CAUSE</b>	<b>VERIFICATION</b>	<b>CORRECTIVE ACTION</b>
<ul style="list-style-type: none"><li>• Low oxygen output</li></ul>	<b>Sieve bed failure</b>  <b>Compressor failure</b>	<ul style="list-style-type: none"><li>• Verify the oxygen output with a calibrated oxygen analyzer</li><li>• Verify the Compressor is working properly</li><li>• Verify that there are no leaks</li><li>• Verify Compressor is operating properly</li></ul>	<ul style="list-style-type: none"><li>• Replace the Sieve Canister</li><li>• Replace the Compressor</li><li>• Replace tubing and clamps</li><li>• Replace Compressor</li></ul>
<ul style="list-style-type: none"><li>• Low Oxygen percentage indicator not functioning</li><li>• Continuous red LED</li></ul>	<b>Main PCA failure</b>	<ul style="list-style-type: none"><li>• Verify the OPI output</li></ul>	<ul style="list-style-type: none"><li>• Replace the Main PCA</li></ul>
<ul style="list-style-type: none"><li>• Warm cabinet temperature</li></ul>	<b>Cooling Fan failure</b>	<ul style="list-style-type: none"><li>• Verify the Cooling Fan connectors are seated properly</li><li>• Verify there is continuity on electrical fan wiring harness</li><li>• Verify there is power to the Cooling Fan</li><li>• Verify the Cooling Fan is not obstructed</li></ul>	<ul style="list-style-type: none"><li>• Reseat the connectors</li><li>• Replace the fan assembly</li><li>• Reseat the connectors</li><li>• Remove the obstructions from the Cooling Fan</li></ul>



<b>SYMPTOM</b>	<b>CAUSE</b>	<b>VERIFICATION</b>	<b>CORRECTIVE ACTION</b>
<ul style="list-style-type: none"> <li>Inaccurate oxygen flow</li> </ul>	<b>Flow Meter failure</b>	<ul style="list-style-type: none"> <li>Verify the Flow Meter can be adjusted properly</li> </ul>	<ul style="list-style-type: none"> <li>Replace the Flow Meter</li> </ul>
<ul style="list-style-type: none"> <li>Loss of power</li> <li>Low Pressure</li> </ul>	<b>Compressor thermal switch failure</b> <ul style="list-style-type: none"> <li>Compressor temperature allowed to exceed 65 +/- 5 degrees C 127 +/- 5 degrees F</li> </ul>	<ul style="list-style-type: none"> <li>Verify that air flow around concentrator is not blocked</li> <li>Verify that all filters are clean</li> <li>Verify that the thermal switch is closing after cooling</li> </ul>	<ul style="list-style-type: none"> <li>Reposition the concentrator to an open area</li> <li>Replace all dirty filters</li> <li>Replace the Compressor</li> </ul>

<b>PROBLEM</b>	<b>POSSIBLE CAUSE</b>	<b>WHAT YOU SHOULD DO</b>
Not running or lockup	Compressor	Replace the compressor
Noisy at the compressor	Compressor	Replace the compressor
Low Flow if the purity is still good	Compressor	Replace the compressor
Valve not cycling	Valve	Replace the valve
Pressure fluctuating < 10psi	Valve	Replace the valve
Flow meter fluctuating, either observed or device returned with customer complaint	Valve	Replace the valve
Customer complaint of device alarming, but the measured O <sub>2</sub> is within spec	Valve	Replace the valve
Low O <sub>2</sub> with the perf-plates at or above 1.3 inches	Valve	Replace the valve
Low O <sub>2</sub> with new valve installed and compressor flow within spec	Canister	Replace the canister
Either the perf-plate position measured >1.3 inches	Canister	Replace the canister and valve
Peak pressure > 28 psi	Canister	Replace the canister and valve
Estimated flow > 5.5 LPM with the flow meter set to = 5 LPM	System checks	Inspect and fix leaks
EverFlo UltraFill compatible models have cuts or pin holes in tubing near the sieve canister	System checks	Inspect and fix leaks

**7.4 SYSTEM PRESSURE TEST TABLE**

<b>SYMPTOM</b>	<b>CAUSE</b>	<b>VERIFICATION</b>	<b>CORRECTIVE ACTION</b>
System Pressure Test <ul style="list-style-type: none"> <li>Abnormal reading</li> </ul>	<ul style="list-style-type: none"> <li>High-pressure reading above 25 psig @ 60 Hz @ 5 LPM flow.</li> </ul>	<ul style="list-style-type: none"> <li>Check oxygen percentage at 5 LPM. If Low?</li> </ul>	<ul style="list-style-type: none"> <li>Check for proper valve cycling</li> <li>Replace Sieve Canister</li> </ul>
<ul style="list-style-type: none"> <li>Fluctuating pressure</li> </ul>	<ul style="list-style-type: none"> <li>Difference in Peak pressure is &gt; 1 psig.</li> </ul>	<ul style="list-style-type: none"> <li>Check oxygen percentage at 5 LPM. If Low?</li> </ul>	<ul style="list-style-type: none"> <li>Check for leaks</li> <li>Replace Sieve Canister</li> </ul>
<ul style="list-style-type: none"> <li>Low pressure reading</li> </ul>	<ul style="list-style-type: none"> <li>Low pressure reading below 20 psig @ 5 LPM</li> </ul>	<ul style="list-style-type: none"> <li>Check oxygen percentage at 5 LPM. If Low?</li> <li>Check for leaks</li> <li>Check tubing</li> <li>Check fittings</li> <li>Check for dirty filters</li> <li>Check Compressor for System Pressure</li> </ul>	<ul style="list-style-type: none"> <li>Replace tubing</li> <li>Replace fittings</li> <li>Replace filters</li> <li>Replace Compressor</li> </ul>

## Chapter 8. REPAIR & REPLACEMENT

### 8.1 OVERVIEW

This chapter illustrates the replaceable components for the EverFlo Oxygen Concentrator. Procedures for replacing the components are also provided in this chapter.

#### NOTE

#### NOTE

#### WARNING

- To prevent electrical shock, disconnect the electrical supply before attempting to make any repairs to the EverFlo Concentrator.
- Use extreme caution when handling the Capacitor. The Capacitor can hold a substantial electrical charge until it is properly discharged.
- Even with the unit disconnected from the electrical supply, the Capacitor may still hold an electrical charge strong enough to cause serious bodily injury. **DO NOT** touch the capacitor terminals simultaneously until the Capacitor has been completely discharged. Discharge the Capacitor by shorting the two posts with an insulated screwdriver.
- Avoid handling the molecular sieve material. Respironics recommends the return of the sieve canister assembly to Respironics for any service that involves sieve material.

#### CAUTION

- Electronic components used in this device are subject to damage from static electricity. Repairs made to this device must be performed only in an antistatic, ESD-protected environment.
- During all repair and replacement procedures, ensure that any connections that are broken during the process (fittings, tubing, and hoses) are reconnected securely.
- When using a leak detector, be careful that it does not come in contact with any electrical components.
- The fuse on the Main PCA must be replaced with the fuse called out in the Repair Kits Section of this Service Manual. Failure to do so will result in damage to the unit.



**8.2 REPAIR KIT REFERENCE TABLE**

<b>PART NUMBER(S)</b>	<b>REPAIR KIT NAME</b>
<b>Capacitor Assembly</b>	
1038834	RP-EverFlo Capacitor Assy-120V
1038835	RP-EverFlo Capacitor Assy-230V
1050251	RP-EverFlo (1020013) Capacitor Assembly
<b>Caster</b>	
1026632	RP- CASTER KIT 1-PACK
1126706	RP-CASTER,LOCKING,4-PACK
<b>Compressor Assembly</b>	
1038822	RP-EverFlo Compressor-120V
1038823	RP-EverFlo Compressor-230V
1110619	RP-EverFlo .380 Stroke Compressor-120V
1110620	RP-EverFlo .380 Compressor w/Return Pack
1134131	RP-EverFlo Compressor-Korea <b>NOTE: Only Model 1020013 uses this kit</b>
1134637	RP - EverFlo GSE compressor 120 Volt
<b>Cover</b>	
1050773	RP-EverFlo Din Outlet Cover
1038839	RP-EverFlo Filter Cover
<b>Label</b>	
1051037	RP-EverFlo Mill Branding LBLs
1051038	RP-Model 1020013 Fire Warn LBL
<b>Overlay</b>	
1053746	RP-EverFlo Overlay Kit
1056622	RP-EverFlo Q Overlay Kit
<b>Tubing</b>	
1135323	RP-EverFlo Compressor Repair Kit
1038833	RP-EverFlo OPI Concentrator Tubing
1075139	RP-EverFlo-T Pressure Regulator Assy
1132529	RP - PRI Compressor Inlet Tube Assembly <b>NOTE: Also requires the use of P/N 1038820</b>
1039642	HUMIDIFIER CONNECTOR TUBE KIT,EVERFLO
1133623	RP,HUMIDIFIER FITTING ONLY(qty100)
<b>Fan Assembly</b>	
1038836	RP-EverFlo Fan Assy-120V
1038837	RP-EverFlo Fan Assy-230V
1056621	RP-EverFlo Model 1020007 Fan Kit
<b>Flow Meter</b>	
1082784	KIT, 5 LPM FLOWMETER, EVERFLO
H644	KIT,LOW RANGE CABINET FLOWMETER
528	KIT, LOCKING FLOWMETER 5LPM
<b>Front Cabinet Assembly</b>	
1038809	RP-EverFlo Front Cabinet Assy-120V

<b>PART NUMBER(S)</b>	<b>REPAIR KIT NAME</b>
1039576	RP-EverFlo Front Cabinet Kit-230V
1050254	RP-EverFlo Q Front Cabinet
<b>Outlet</b>	
1038830	RP-EverFlo Front Cabinet DISS Outlet
<b>Hardware</b>	
1121100	RP-KIT,CABLE TIE, 11 1/2 IN LG(X1000)
1038841	RP-EverFlo Hardware
1116864	RP-Torx, T6 Insert Bit Kit
1116865	RP-Torque Driver Kit 1.5 to 15 in-lbs
1132614	RP-EverFlo SMC 19mm Hdwr Kit
1111250	RP-EverFlo SMC Hardware Kit
1114955	RP-EverFlo ASCO Screw Kit (X100)
1119432	RP-EverFlo #6-19 Screw/Washer Kit (X200)
<b>Strap</b>	
1038840	RP-EverFlo Humidifier Strap
<b>Inlet</b>	
1038820	RP-EverFlo Inlet Boot
1038831	RP-EverFlo Inlet Filter
<b>Main PCA</b>	
1136061	RP Kit-PCA,ROHS,EVERFLO w LCD,DOM,NONOX
1136062	RP Kit-PCA,ROHS,EVERFLO w LCD,DOM,OX
1136063	RP Kit-PCA,ROHS,EVERFLO w LCD,INT,OX
<b>Filter</b>	
520	KIT,OXYGEN MICRODISK FILTERS
<b>Coupler</b>	
1081743	RP-O2 Quick Coupler
<b>Packaging and Returns</b>	
1038842	RP-EverFlo Packaging
1046753	RP-EverFlo Compressor w/ Return Pack
1113951	EF Compr Kit,120V,.44 stroke,90PC,BULK
1113952	EF Compr Kit,230V,.44 stroke,90PC,BULK
1113953	EF Compr Kit,120V,.38 stroke,90PC,BULK
1132718	RP-Everflo Pulp Packaging Bulk Kit
1135771	RP-Everflo Pulp Packaging Bulk Kit-Latin
1135772	RP-Everflo Pulp PackagingBulk Kit-Europe
1121593	RP-EverFlo Packaging FR
<b>Power Cords</b>	
1129417	RP-EverFlo,Pwr Cord,Domestic,STRLF
1129518	RP-EverFlo,Pwr Cord,NEMA,120V, STRLF
1129519	RP-EverFlo,Pwr Cord,Europe, STRLF
1069012	RP-EverFlo,Pwr Cord,UK,Ireland,STRL
1129521	RP-EverFlo,Pwr Cord,Australia,STRLF

<b>PART NUMBER(S)</b>	<b>REPAIR KIT NAME</b>
1129522	RP-EverFlo,Pwr Cord,Italy,Chile,STRLF
1129526	RP-EverFlo,Pwr Cord,Brazil,120V,STRLF
1129520	RP-EverFlo,Pwr Cord,S.Africa,India,STRLF
1129523	RP-EverFlo,Pwr Cord,Argentina,STRLF
1129524	RP-EverFlo,Pwr Cord,Korea,STRLF
1129525	RP-EverFlo,Pwr Cord,Switzerland,STRLF
<b>Pressure Regulator</b>	
1038838	RP-EverFlo Pressure Regulator Adaptor
1038824	RP-EverFlo Pressure Regulator Assy.
1075139	RP-EverFlo-T Pressure Regulator Assy
1092138	RP-EverFlo Reg to O2 Coupler
1119969	RP-EverFlo T Pressure Regulator Adaptor
<b>Rear Cabinet Assembly</b>	
1038810	RP-EverFlo Rear Cabinet Assy-120V
1039577	RP-EverFlo Rear Cabinet-230V
1050253	RPKit-EverFlo 1020007 Rear Cabinet Assy
1050252	RP-EverFlo Q Rear Cabinet
<b>Sieve Canister Assembly</b>	
1038825	RP-EverFlo Canister Assy .035x11.5 <b>NOTE: Do not use with GSE Compressor</b>
1050248	RP-EverFlo Canister Assy .035x12.5
1052382	RP-EverFlo Canister Assy .032x12.5
<b>Solenoid Assembly</b>	
1109961	RP-EverFlo O2 Pilot Solenoid Assy
1115003	RP-EverFlo ASCO Valve Body, O2 Pilot
1111249	RP-EverFlo SMC Pilot Valve Kit
1111248	RP-EverFlo SMC Valve Body Kit
1114952	RP-EverFlo ASCO Valve Body Kit
1114954	RP-EverFlo ASCO Pilot Valve Kit
<b>Spring</b>	
1052355	RP-EverFlo Spring Kit
<b>Whisper Cap</b>	
1048534	RP-EverFlo Whisper Cap Kit
<b>Compressor Test Equipment</b>	
1008198	HOSE,22mm-18IN,NON-AUTOCLAV
1071679	1071679
<b>Oxygen Interface</b>	
1073499	Oxygen Interface Hardware Kit
1129195	RP-CABLE, MDIN7, MALE, MALE, 6FT
<b>Oxygen Test Flowmeter</b>	
1106611	RP-OXYGEN TEST FLOW METER
<b>Foam</b>	
1120993	RP-FOAM STOP,COMPRESSOR,EVERFLO (x8)

### 8.3 FILTER COVER REPLACEMENT

#### To Remove the Filter Cover

1. Using minimal force, apply pressure to the outside of the Filter Cover.

#### To install the Filter Cover

1. Place Filter Cover tab into slot.
2. Push the Filter Cover in until it locks.

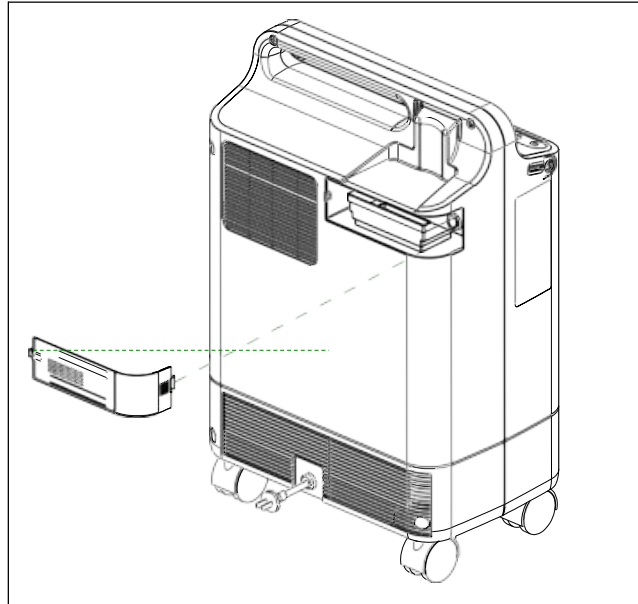

**Figure 8-1: FILTER COVER REPLACEMENT**

## 8.4 INLET FILTER REPLACEMENT

### To remove the Inlet Filter

1. Remove the Filter Cover. Refer to the Refer to the Filter Cover Replacement section for more information.
2. Remove the Inlet Filter.

### To install the Inlet Filter

1. Fully seat the Inlet Filter into the Inlet Boot.
2. Install the Filter Cover.

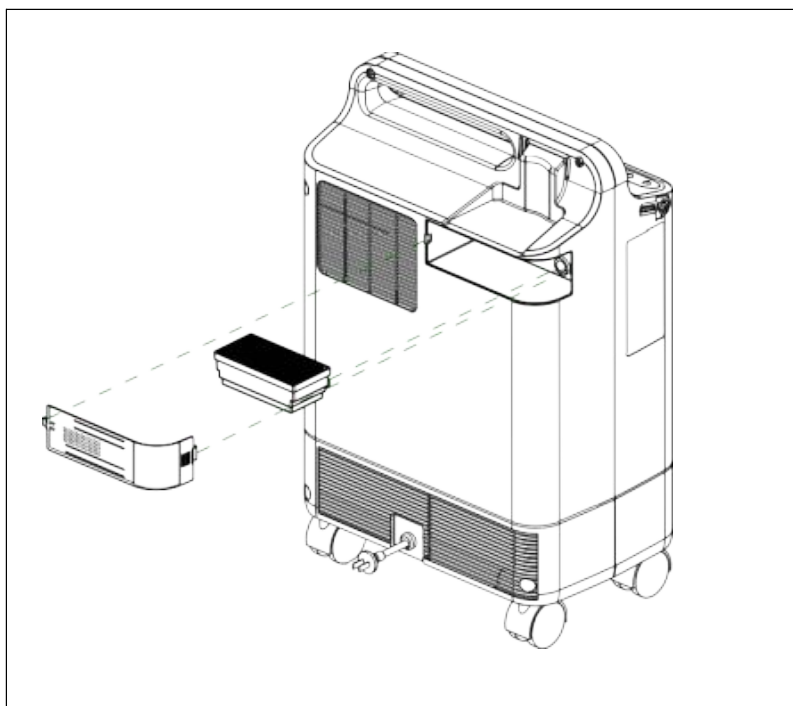
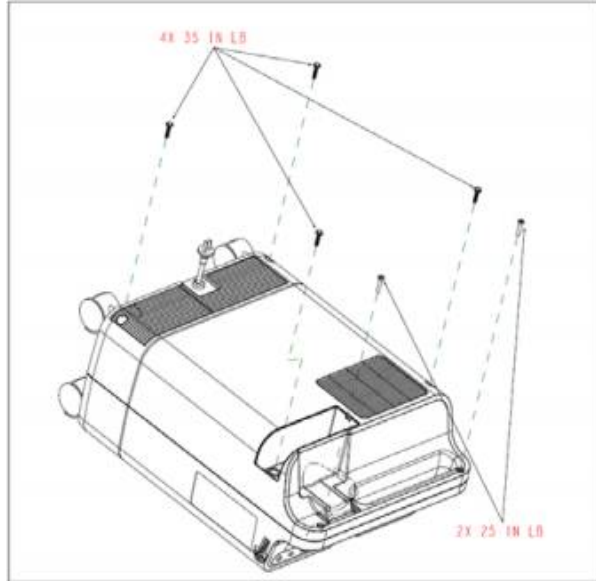

**Figure 8-2: INLET FILTER REPLACEMENT**

## 8.5 REAR CABINET/POWER CORD REPLACEMENT

### To remove the Rear Cabinet/Power Cord

1. Place the concentrator face down on an ESD Protected surface.
2. Remove the Filter Cover. Refer to the Filter Cover Replacement section for more information.
3. Remove the Inlet Filter. Refer to the Inlet Filter Replacement section for more information.
4. Remove the two phillips screws from the handle of the Rear Cabinet.
5. Remove the four hex screws from the Rear Cabinet.



**Figure 8-3: SCREW REMOVAL/INSTALLATION**

6. Lifting the Rear Cabinet slightly up from the Front Cabinet, fold the Rear Cabinet away from the Front Cabinet.



**Figure 8-4: EVERFLO REPAIR POSITION**

7. Cut the two tie wraps securing the Power Cord to the Sieve Canister.



**Figure 8-5: TIE WRAP LOCATION**

8. Unclip the Main PCA shield from the Front Cabinet and push the PCA toward the bottom of the cabinet until the power switch clears the front cabinet.

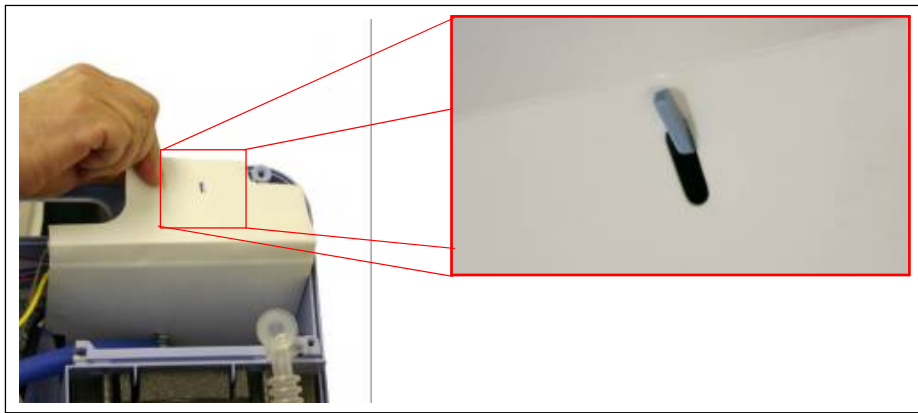

**Figure 8-6: UNCLIP MAIN PCA**

9. Lift Main PCA out of the Front Cabinet.

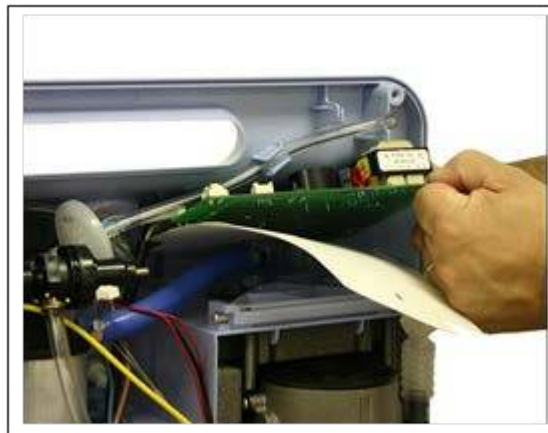

**Figure 8-7: MAIN PCA REMOVAL**

10. Remove the Power Cord wires from the J3 and J4 locations of the Main PCA.
11. Use a large, flat bladed screwdriver to push in the tabs on the top of the strain relief and the bottom strain relief to remove the Power Cord from the Rear Cabinet.



**Figure 8-8: STRAIN RELIEF REMOVAL**

**To install the Rear Cabinet/Power Cord**

1. Thread the Power Cord through the hole in the Rear Cabinet. A set of bent needle nose pliers will help with the installation of the power cord.
2. Connect the Power Cord connectors to the J3 and J4 locations of the Main PCA. Refer to Figure 8-15.
3. Slide the Main PCA into the grooves in the Front Cabinet.
4. Secure the Power Cord Wires against the Sieve Canister with two cable ties.
5. Place the Rear Cabinet onto the Front Cabinet.
6. Secure the Front and Rear Cabinets together by torquing the four hex screws (35 in-lbs.) and two phillips screws (25 in-lbs.).
7. Install the Inlet Filter. Refer to the Inlet Filter Replacement section for more information.
8. Install the Filter Cover. Refer to the Filter Cover Replacement section for more information.



## 8.6 O<sub>2</sub> QUICK COUPLER REPLACEMENT

### To remove the O<sub>2</sub> Quick Coupler

1. Remove the Filter Cover. Refer to the Filter Cover Replacement section for more information.
2. Remove the Inlet Filter. Refer to the Inlet Filter Replacement section for more information.
3. Remove the Rear Cabinet. Refer to the Rear Cabinet/Power Cord Replacement section for more information.
4. Cut the tie wrap securing the tubing to the O<sub>2</sub> Coupler.



5. Remove the securing nut from the coupler and push the coupler towards the outside of the device to remove.

### To install the O<sub>2</sub> Coupler

1. Insert the O<sub>2</sub> Coupler through the side wall threads toward the inside of the device ensuring that the flat "D" portion of the Coupler is aligned with the flat "D" portion of the pass through hole.
2. Install the securing nut to the O<sub>2</sub> Coupler and tighten.
3. Install the tubing to the O<sub>2</sub> Coupler.
4. Secure the tubing to the O<sub>2</sub> Coupler using a tie wrap.
5. Install the Rear Cabinet. Refer to the Rear Cabinet/Power Cord Replacement section for more information.
6. Install the Inlet Filter. Refer to the Inlet Filter Replacement section for more information.
7. Install the Filter Cover. Refer to the Filter Cover Replacement section for more information.

## 8.7 EVERFLO AND EVERFLO Q PRESSURE REGULATOR ASSEMBLY REPLACEMENT

### To remove the Pressure Regulator Assembly

1. Remove the Filter Cover. Refer to the Filter Cover Replacement section for more information.
2. Remove the Inlet Filter. Refer to the Inlet Filter Replacement section for more information.
3. Remove the Rear Cabinet. Refer to the Rear Cabinet/Power Cord Replacement section for more information.
4. Gently remove the yellow pressure line coming from the Pressure Regulator Adaptor.

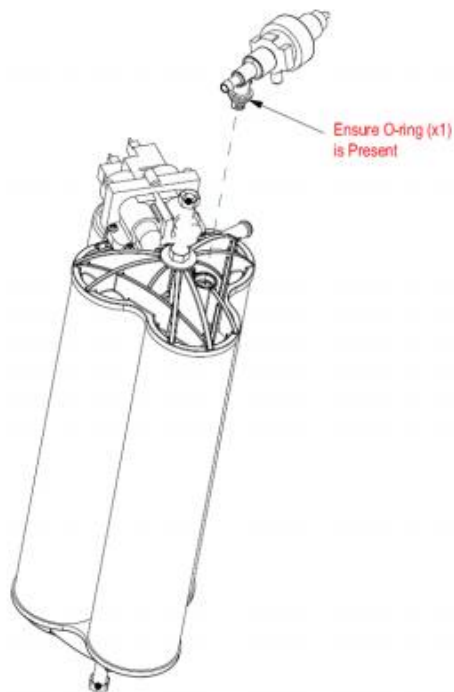

**Figure 8-9: REMOVE YELLOW PRESSURE LINE**

5. Unlock the Pressure Regulator Adaptor by twisting upwards until the Pressure Regulator stops.
6. Lift the Pressure Regulator Assembly straight up until it clears the Sieve Canister Assembly.
7. Using pliers, loosen the clamp and disconnect the flow tubing from the Pressure Regulator Assembly.

### To install the Pressure Regulator Assembly

1. Using pliers, clamp the flow tubing to the Pressure Regulator Assembly.
2. Place the Pressure Regulator Assembly in place by lining the Pressure Regulator Adaptor up with the grooves in the Sieve Canister Assembly.
3. Lock the Pressure Regulator Assembly in place by turning the Assembly downwards.



**Figure 8-10: PRESSURE REGULATOR ASSEMBLY REMOVAL/INSTALLATION**

4. Connect the yellow pressure line to the Pressure Regulator Adaptor. Refer to Figure 8-9.
5. Install the Rear Cabinet. Refer to the Rear Cabinet/Power Cord Replacement section for more information.
6. Install the Inlet Filter. Refer to the Inlet Filter Replacement section for more information.
7. Install the Filter Cover. Refer to the Filter Cover Replacement section for more information.

## 8.8 EVERFLO ULTRAFILL COMPATIBLE PRESSURE REGULATOR ASSEMBLY REPLACEMENT

### To remove the Pressure Regulator Assembly

1. Remove the Filter Cover. Refer to the Filter Cover Replacement section for more information.
2. Remove the Inlet Filter. Refer to the Inlet Filter Replacement section for more information.
3. Remove the Rear Cabinet. Refer to the Rear Cabinet/Power Cord Replacement section for more information.
4. Gently remove the yellow pressure line coming from the Pressure Regulator Adaptor.



**Figure 8-11: PRESSURE LINE REMOVAL**

5. Cut the tie wrap securing the tubing to the Pressure Regulator Adaptor and the O<sub>2</sub> Coupler and remove the tubing.

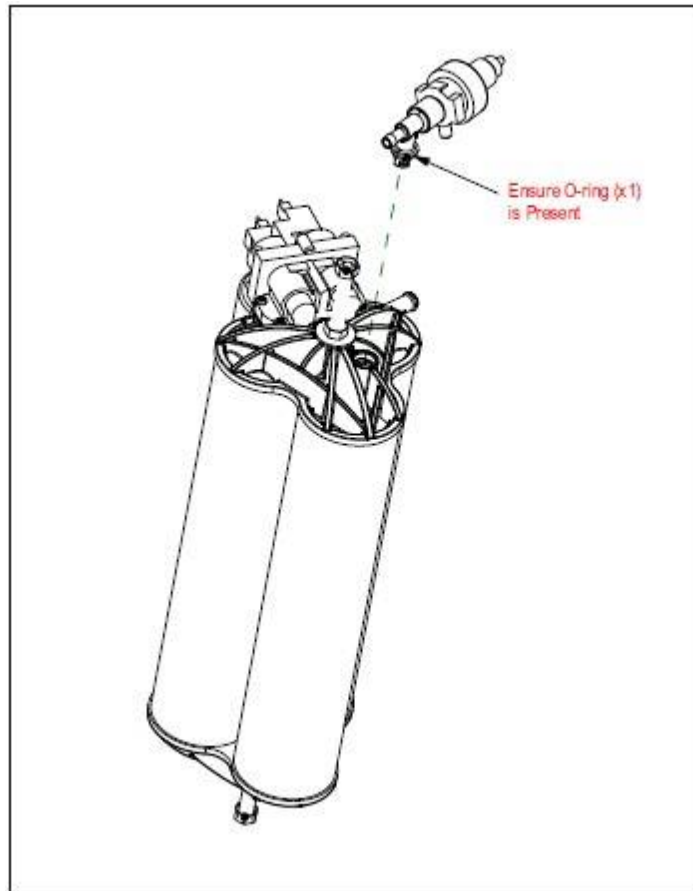

**Figure 8-12: TIE WRAP LOCATIONS**

6. Unlock the Pressure Regulator Adaptor by twisting upwards until the Pressure Regulator stops.
7. Lift the Pressure Regulator Assembly straight up until it clears the Sieve Canister Assembly.
8. Using pliers loosen the clamp and disconnect the flow tubing from the Pressure Regulator Assembly.

**To install the Pressure Regulator Assembly**

1. Using pliers, clamp the flow tubing to the Pressure Regulator Assembly.
2. Place the Pressure Regulator Assembly in place by lining the Pressure Regulator Adaptor up with the grooves in the Sieve Canister Assembly.
3. Lock the Pressure Regulator Assembly in place by turning the Assembly downwards.

**Figure 8-13: INSTALLING THE PRESSURE REGULATOR**

4. Install the clear tubing to the O<sub>2</sub> Coupler and secure with a tie wrap.
5. Route the clear tubing under the Sieve Canister Assembly.

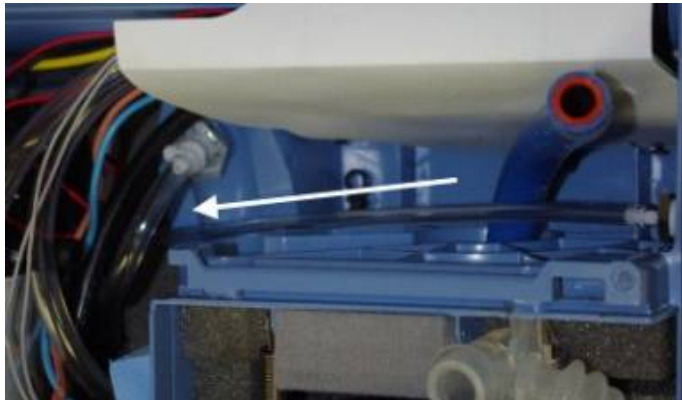

**Figure 8-14: CLEAR TUBING POSITION**

6. Install the clear tubing to the Pressure Regulator Adapter outlet and secure with a tie wrap.
7. Connect the yellow pressure line to the Pressure Regulator Adapter.
8. Install the Rear Cabinet. Refer to the Rear Cabinet/Power Cord Replacement section for more information.
9. Install the Inlet Filter. Refer to the Inlet Filter Replacement section for more information.
10. Install the Filter Cover. Refer to the Filter Cover Replacement section for more information.

## 8.9 MAIN PCA REPLACEMENT

Reference Table for Original and New Release Parts, Listed by Model Number

Model	First Serial Number w/o Purge Valve	Sieve Bed - Unit w/ Purge Valve	Sieve Bed - Unit w/o Purge Valve	Main PCA - Unit w/ Purge Valve	Main PCA - Unit w/o Purge Valve
1020000	Since Initial Release	N/A	1038825	N/A	1136061
1020001	Since Initial Release	N/A	1038825	N/A	1136062
1020002	Since Initial Release	N/A	1038825	N/A	1136062
1020002BR	Since Initial Release	N/A	1038825	N/A	1136062
1020003	Since Initial Release	N/A	1038825	N/A	1136061
1020003BR	Since Initial Release	N/A	1038825	N/A	1136061
1020004	> 0009138	1038826	1050248	1038816	1136063
1020005	> 0001456	1038826	1050248	1060160	1136063
1020006	> 0027082	1038826	1052382	1038817	1136063
1020007	> 00008249	1038826	1052382	1038816	1136063
1020008	0004052	1038826	1052382	1038816	1136063
1020009	0002514	1038826	1052382	1038817	1136063
1020010	0006595	1038826	1052382	1038817	1136063
1020011	0002455	1038826	1052382	1038817	1136063
1020012	0002863	1038826	1052382	1038817	1136063
1020013	Since Initial Release	N/A	1050248	N/A	1136063
1020014	Since Initial Release	N/A	1050247	N/A	1136062
1020015	Since Initial Release	N/A	1050247	N/A	1136061
1020016	0001285	1038826	1052382	1038817	1136063
1020017	0002734	1038826	1052382	1038817	1136063

### To remove the Main PCA

1. Remove the Filter Cover. Refer to the Filter Cover Replacement section for more information.
2. Remove the Inlet Filter. Refer to the Inlet Filter Replacement section for more information.
3. Remove the Rear Cabinet. Refer to the Rear Cabinet/Power Cord Replacement section for more information.
4. Unclip the Main PCA shield from the locking tab on the Front Cabinet. Refer to Figure 8-7.



5. Remove the Power Cord Connectors from the J3 and J4 locations of the Main PCA. Refer to Figure 8-15.
6. Remove the Fan Connector from the J9 location of the Main PCA. Refer to Figure 8-15.
7. Remove the Valve Solenoid Connector from the J7 location of the Main PCA. Refer to Figure 8-15.
8. Remove the Purge Valve Connector from the J8 location of the Main PCA (230V devices equipped with a Purge Valve Only). Refer to Figure 8-15.
9. Gently remove the yellow pressure line coming from the Pressure Regulator Adaptor from the pressure sensor (SN1) of the Main PCA. Refer to Figure 8-15.
10. Remove the two pieces of flow tubing from the OPI sensor on the Main PCA (OPI devices only). Refer to Figure 8-15.
11. Slide the Main PCA upward from the grooves in the Front Cabinet.
12. Remove the Compressor Wires from the J2 and J6 locations of the Main PCA. Refer to Figure 8-15.

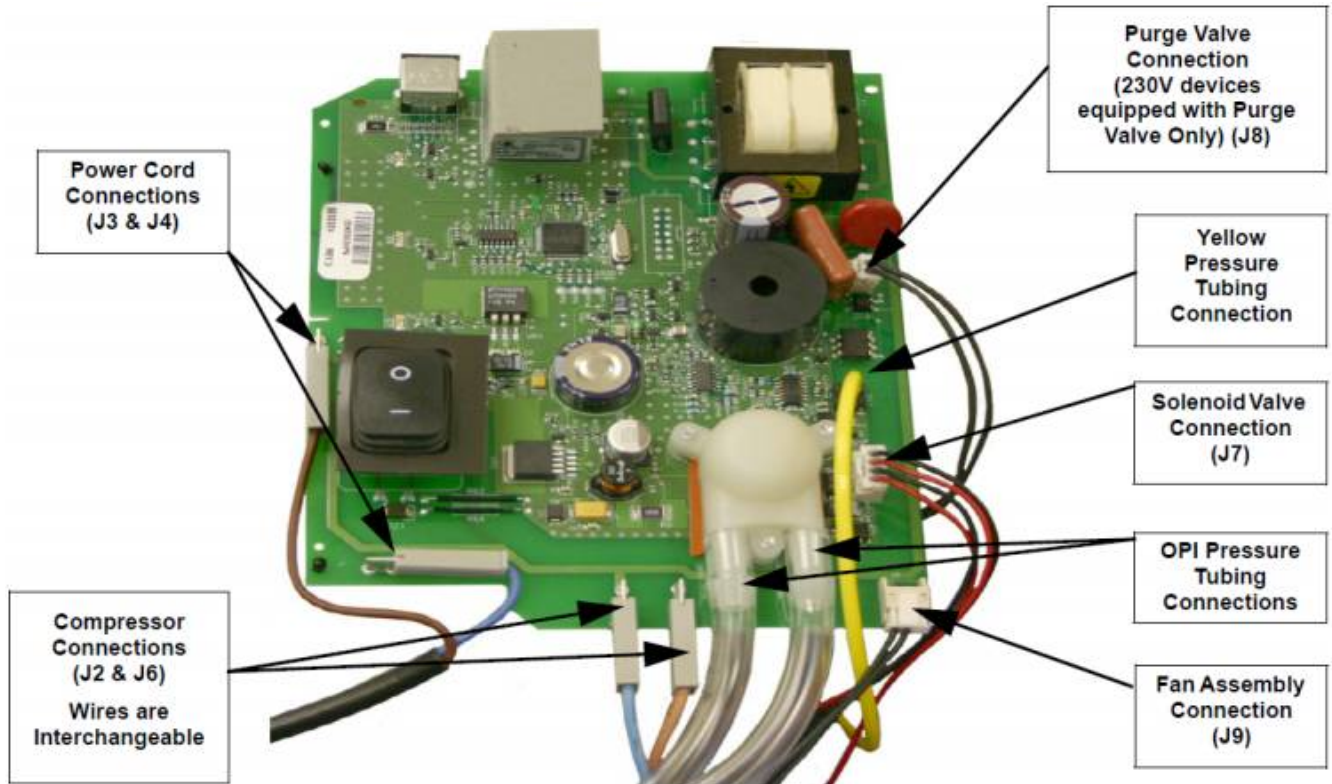

**Figure 8-15: CONNECTION POINTS ON THE MAIN PCA**





**Figure 8-16: Example PCA Equipped with LCD Hour Meter**

**To install the Main PCA**

**Note**

EverFlo devices originally equipped with the LCD PCA (see Figure 8-16) may only have LCD PCA RP kits as replacements. EverFlo devices with older PCAs, (i.e., with analog hour meters) may use the LCD PCA RP kits as replacements for faulty PCAs.

1. Connect the yellow pressure line coming from the Pressure Regulator Adaptor to the pressure sensor, location SN1, of the Main PCA.
2. Connect the two pieces of flow tubing to the flow sensor of the Main PCA (OPI devices Only).

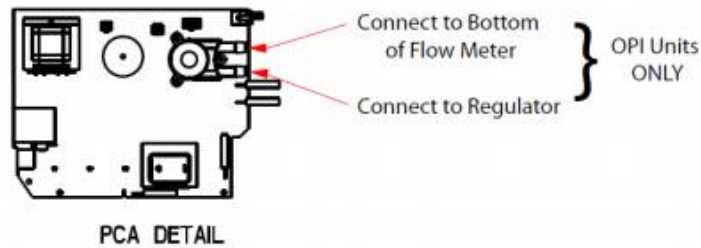

3. Connect the Valve Solenoid connector to the J7 location of the Main PCA. Refer to Figure 8-15.
4. Connect the Fan Connector to the J9 location of the Main PCA. Refer to Figure 8-15.
5. Connect the Compressor Connectors to the J2 and J6 locations of the Main PCA. The Compressor wires are interchangeable. Refer to Figure 8-15.
6. Connect the Purge Valve Connector to the J8 location of the Main PCA (230V devices equipped with a Purge Valve Only). Refer to Figure 8-15.
7. Connect the Power Cord Connectors to the J3 and J4 locations of the Main PCA. The long wire should be connected at J3 and the shorter wire connected at J4. Refer to Figure 8-15.
8. Place the Main PCA into the grooves in the Front Cabinet.
9. Connect the Main PCA shield to the Front Cabinet locking tab.
10. Install the Rear Cabinet. Refer to the Rear Cabinet/Power Cord Replacement section for more information.
11. Install the Inlet Filter. Refer to the Inlet Filter Replacement section for more information.
12. Install the Filter Cover. Refer to the Filter Cover Replacement section for more information.

**8.10 SIEVE CANISTER ASSEMBLY REPLACEMENT**

**Note**

The 230V EverFlo Concentrators have been updated. All 230V models will now be manufactured without a purge valve. To support this change the release of a new Main PCA and Sieve Canister were required.

It is possible to install these new release repair parts into an original unit with the Purge Valve, but both the Main PCA and Sieve Canister without purge valve will need to be replaced.

**Reference Table for Original and New Release Parts, Listed by Model Number**

<b>Model</b>	<b>First Serial Number w/o Purge Valve</b>	<b>Sieve Bed - Unit w/ Purge Valve</b>	<b>Sieve Bed - Unit w/o Purge Valve</b>	<b>Main PCA - Unit w/ Purge Valve</b>	<b>Main PCA - Unit w/o Purge Valve</b>
1020000	Since Initial Release	N/A	1038825	N/A	1136061
1020001	Since Initial Release	N/A	1038825	N/A	1136062
1020002	Since Initial Release	N/A	1038825	N/A	1136062
1020002BR	Since Initial Release	N/A	1038825	N/A	1136062
1020003	Since Initial Release	N/A	1038825	N/A	1136061
1020003BR	Since Initial Release	N/A	1038825	N/A	1136061
1020004	> 0009138	1038826	1050248	1038816	1136063
1020005	> 0001456	1038826	1050248	1060160	1136063
1020006	> 0027082	1038826	1052382	1038817	1136063
1020007	> 00008249	1038826	1052382	1038816	1136063
1020008	0004052	1038826	1052382	1038816	1136063
1020009	0002514	1038826	1052382	1038817	1136063
1020010	0006595	1038826	1052382	1038817	1136063
1020011	0002455	1038826	1052382	1038817	1136063
1020012	0002863	1038826	1052382	1038817	1136063
1020013	Since Initial Release	N/A	1050248	N/A	1136063
1020014	Since Initial Release	N/A	1050247	N/A	1136062
1020015	Since Initial Release	N/A	1050247	N/A	1136061
1020016	0001285	1038826	1052382	1038817	1136063
1020017	0002734	1038826	1052382	1038817	1136063

**To remove the Sieve Assembly**

1. Remove the Filter Cover. Refer to the Filter Cover Replacement section for more information.
2. Remove the Inlet Filter. Refer to the Inlet Filter Replacement section for more information.
3. Remove the Rear Cabinet. Refer to the Rear Cabinet/Power Cord Replacement section for more information.
4. Remove the Pressure Regulator Adaptor. Refer to the O2 Quick Coupler Replacement section for more information.
5. Remove the Valve Solenoid connector from the J7 location of the Main PCA.
6. Remove the Purge Valve Connector from the J8 location of the Main PCA (230V devices equipped with a Purge Valve Only).

**Figure 8-17: PURGE VALVE LOCATION ON SIEVE CANISTER ASSEMBLY**

7. Disconnect the blue hose going from the Compressor to the Sieve Canister Assembly.
8. Lift the Sieve Canister Assembly up and out of the slots located in the Front Cabinet.

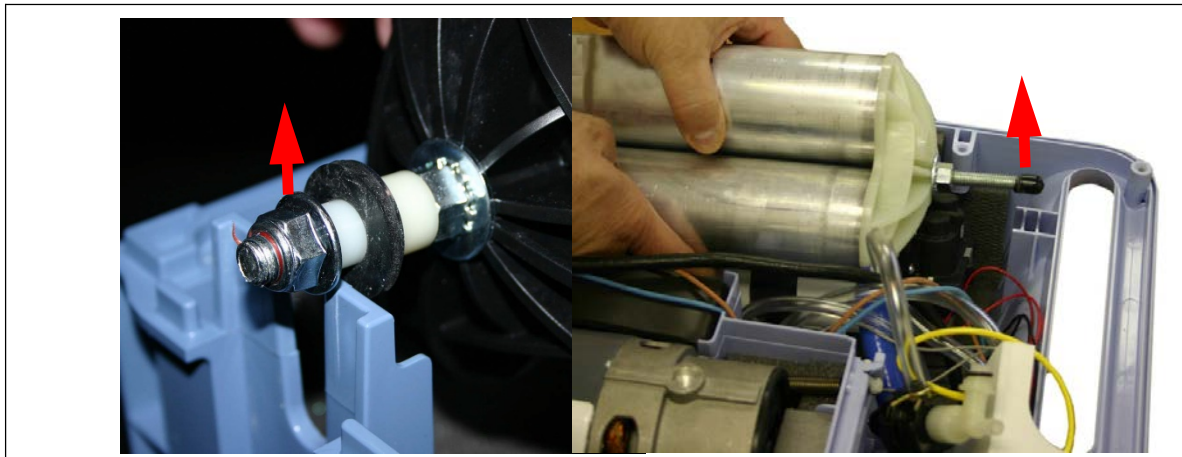
**Figure 8-18: SIEVE CANISTER ASSEMBLY REMOVAL**

9. Remove the Solenoid Valve Assembly from the Sieve Canister Assembly by removing the five philips head screws.

**To install the Sieve Assembly**

1. Install the Solenoid Valve Assembly. Refer to the Valve Solenoid Replacement section for more information.
2. Slide the Sieve Canister Assembly into the hole in the bottom of the Front Cabinet.
3. Place the top and bottom of the Sieve Canister Assembly into the guide slots in the Front Cabinet.

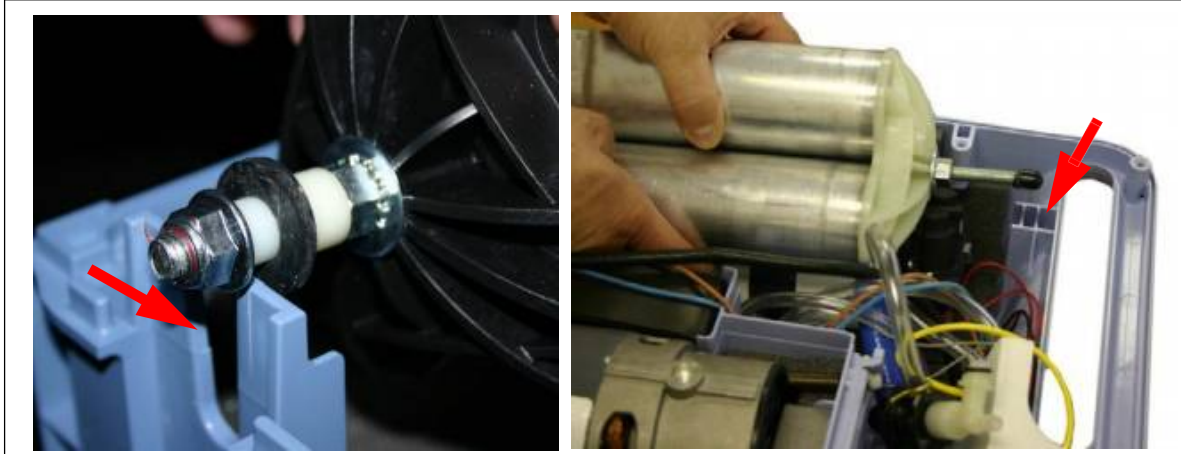

**Figure 8-19: SLOT LOCATIONS**

4. Connect the blue hose from the Compressor to the Sieve Canister Assembly.
5. Connect the Valve Solenoid connector to J7 of the Main PCA.
6. Connect the Purge Valve connector to J8 of the Main PCA (230V devices equipped with a Purge Valve Only).
7. Install the Pressure Regulator Assembly. Refer to the O2 Quick Coupler Replacement section for more information.
8. Install the Rear Cabinet. Refer to the Rear Cabinet/Power Cord Replacement section for more information.
9. Install the Inlet Filter. Refer to the Inlet Filter Replacement section for more information.
10. Install the Filter Cover. Refer to the Filter Cover Replacement section for more information.
11. Install the Inlet Filter. Refer to the Inlet Filter Replacement section for more information.

**NOTE**

Devices manufactured after 06/18/2013 will be equipped with longer sieve canisters (P/Ns 1050248 & 1052382). Unless the unit is a Trans Fill capable or International model, the unit will use P/N 1050248; otherwise, P/N 1052382 is used. Older devices will be equipped with shorter sieve canisters (P/N 1038825).

<b>Model</b>	<b>Model Description</b>	<b>Serial Number Cutoff</b>
1020000	EVERFLO DOM NON- OPI 120V US/CAN	0563182 or higher
1020001	EVERFLO DOM OPI 120V US/CAN	0199183-0199282 and 0207578 or higher
1020002	EVERFLO INTL OPI 120V L.A.	0089982 or higher
1020002BR	EVERFLO,120V,OPI,BRAZIL	0003744 or higher
1020003	EVERFLO INTL NON-OPI 120V L.A.	0015500 or higher
1020003BR	EVERFLO,120V,BRAZIL	0003744 or higher
1020004	EVERFLO INTL OPI 220V L.A./BRAZIL	0007100 or higher
1020006	EVERFLO INTL OPI 230V EU	'0116164 or higher
1020007	EVERFLO INTL OPI 230V IKK	0076950 or higher
1020008	EVERFLO INTL OPI 230V U.K./IRELAND	0018570 or higher
1020009	EVERFLO INTL OPI 230V S. AFRICA	0014559 or higher
1020011	EVERFLO INTL OPI 230V ITALY/CHILE	'0008657 or higher
1020012	Everflo Intl OPI 230V Argentina	0008174 or higher
1020014	EVERFLO Q DOM OPI 120V US/CAN	0058836-0058899 and 0062100-0062146
1020015	EVERFLO Q DOM NON OPI 120V US/CAN	0046353 or higher
1020016	EverFlo Intl OPI 230V HK	0004389 or higher
1020017	EverFlo Intl OPI 230V SWTZ	0004638 or higher
1020020	EVERFLO INTL OPI 230V CHINA	0002476 or higher
1102443	EVERFLO,OPI 230V/60HZ,SAUDI ARABIA	0001593 or higher
<b>EverFlo T</b>	<b>Model Description</b>	<b>Serial Number Cutoff</b>
1039362	EverFlo 120V Dom, UltraFill	'0009824 or higher
1039363	EverFlo 120V OPI Dom, UltraFill	0021951-0022030 and 0021730-0021748 and 0021622
1039364	EverFlo Quiet 120V OPI, Dom, UltraFill	0007247-0007331 and 0006853-0006867
1039365	EverFlo Quiet 120V, Dom, UltraFill	0003271 or higher
1039366	EverFlo 230V OPI, CEE7/7, EUR, UltraFill	0002959 or higher



## 8.11 VALVE SOLENOID REPLACEMENT

### NOTE

There have been three different types/manufacturers of Solenoid Valves:

- SMC (air piloted, original type solenoid valve, used from initial product launch until approximately 6/13)
- ASCO (air piloted, original type solenoid valve used from approximately 12/11 until 6/13)
- ASCO (oxygen piloted, current on all models, used from 6/13/ and future)

#### To remove the Valve Solenoid Assembly

1. Remove the Filter Cover. Refer to the Filter Cover Replacement section for more information.
2. Remove the Inlet Filter. Refer to the Inlet Filter Replacement section for more information.
3. Remove the Rear Cabinet. Refer to the Rear Cabinet/Power Cord Replacement section for more information.
4. Remove the Sieve Canister Assembly. Refer to the Sieve Canister Assembly Replacement section for more information.
5. Remove the five screws and washers securing the Valve Solenoid Assembly to the Sieve Canister Assembly.
6. Remove the pilot valve tubing.

#### To install the Valve Solenoid Assembly

1. Place the Valve Solenoid onto the top of the Sieve Canister in the proper location.
2. Place a washer under the one screw as outlined in the picture below.

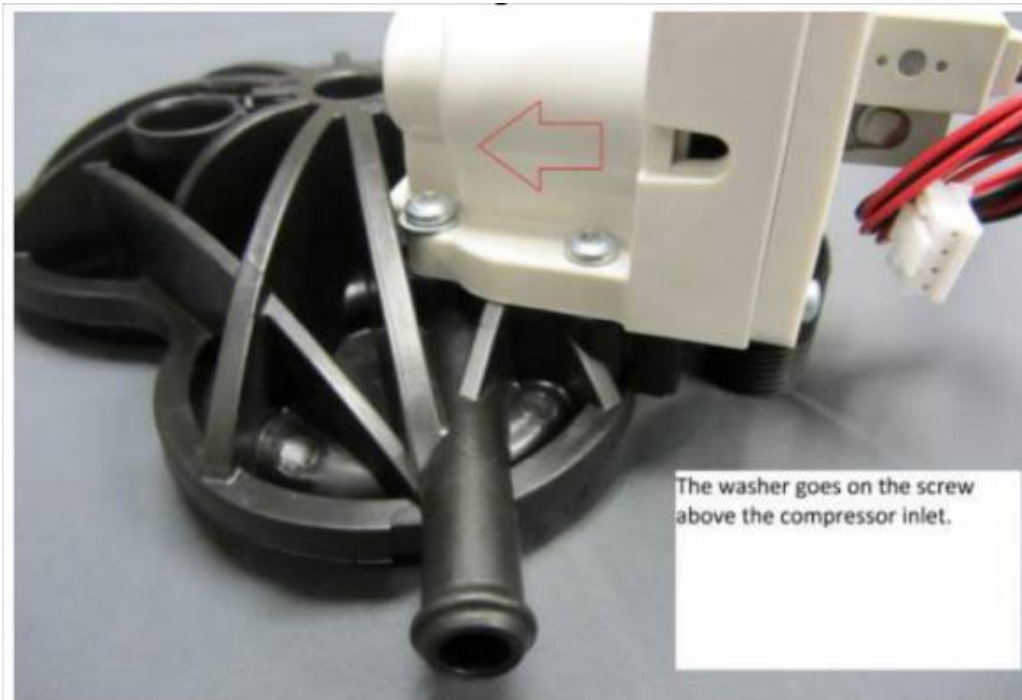

3. Secure the Valve Solenoid Assembly to the Sieve Canister Assembly by securing the five screws to 8 in-lbs. using the torque sequence listed in Refer to Figure 8-19.

**CAUTION**

4. Replace cable ties, ensuring the cable ties are facing downward towards the valve body, as shown below.

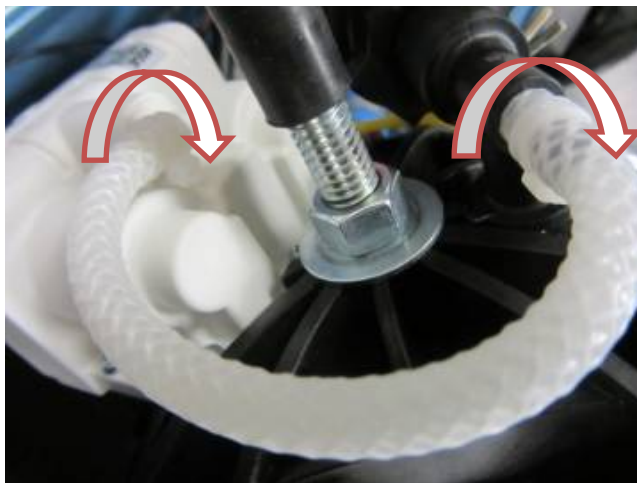



5. Torque specifications for the pilot valves are 1.5 in-LBS or 1.7 cm-KG. (T6 TORX size bit.) as shown below.

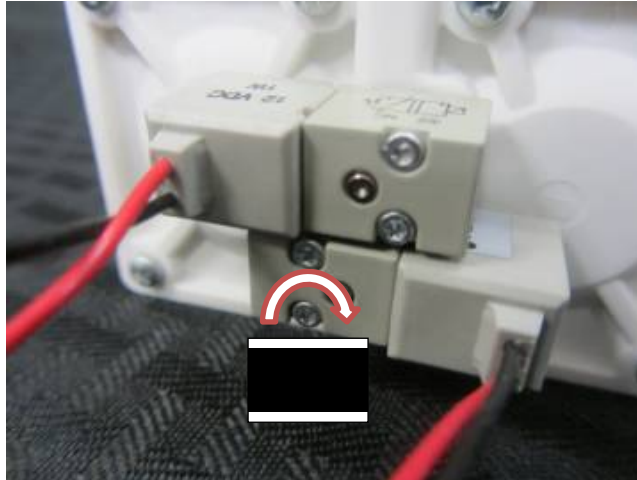

6. Install the Sieve Canister Assembly. Refer to the Sieve Canister Assembly Replacement section for more information.
7. Install the Rear Cabinet. Refer to the Rear Cabinet/Power Cord Replacement section for more information.
8. Install the Inlet Filter. Refer to the Inlet Filter Replacement section for more information.

9. Install the Filter Cover. Refer to the Filter Cover Replacement section for more information.

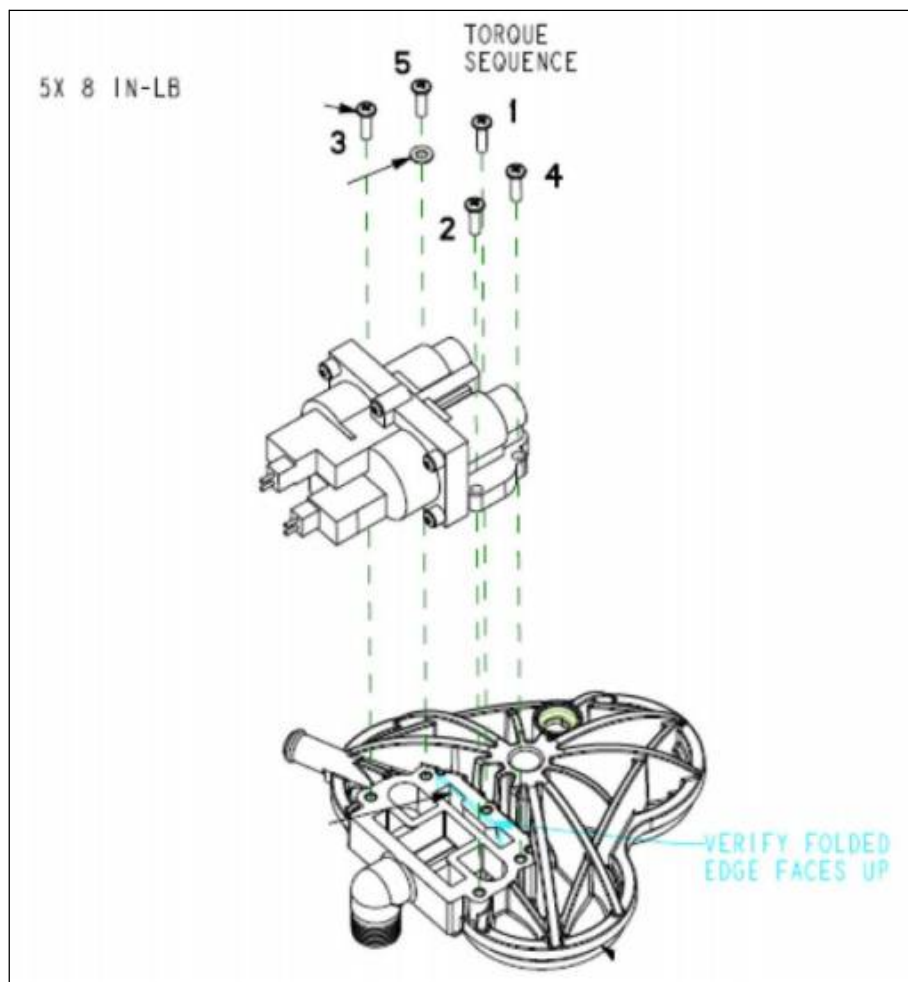

**Figure 8-20: VALVE SOLENOID ASSEMBLY REMOVAL/INSTALLATION**

**NOTE**

Devices manufactured after 06/18/2013 will be equipped with the O2 piloted valve. See Section 8.2 for RP Kit P/Ns. See Section 8.10 for a Serial No. cutoff for various EverFlo models with the O2 piloted valve.

## 8.12 COOLING FAN REPLACEMENT

### To remove the Cooling Fan

1. Remove the Filter Cover. Refer to the Filter Cover Replacement section for more information.
2. Remove the Inlet Filter. Refer to the Inlet Filter Replacement section for more information.
3. Remove the Rear Cabinet. Refer to the Rear Cabinet/Power Cord Replacement section for more information.
4. Unlock the Main PCA shield from the locking tab on the Front Cabinet.
5. Remove the Cooling Fan Connector from the J9 location of the Main PCA.
6. Remove the Cooling Fan Wire Clip.
7. Lift the Cooling Fan up and out of mounting.

### To install the Cooling Fan

1. Place the Cooling Fan into the mounting location in the Front Cabinet.

**WARNING**

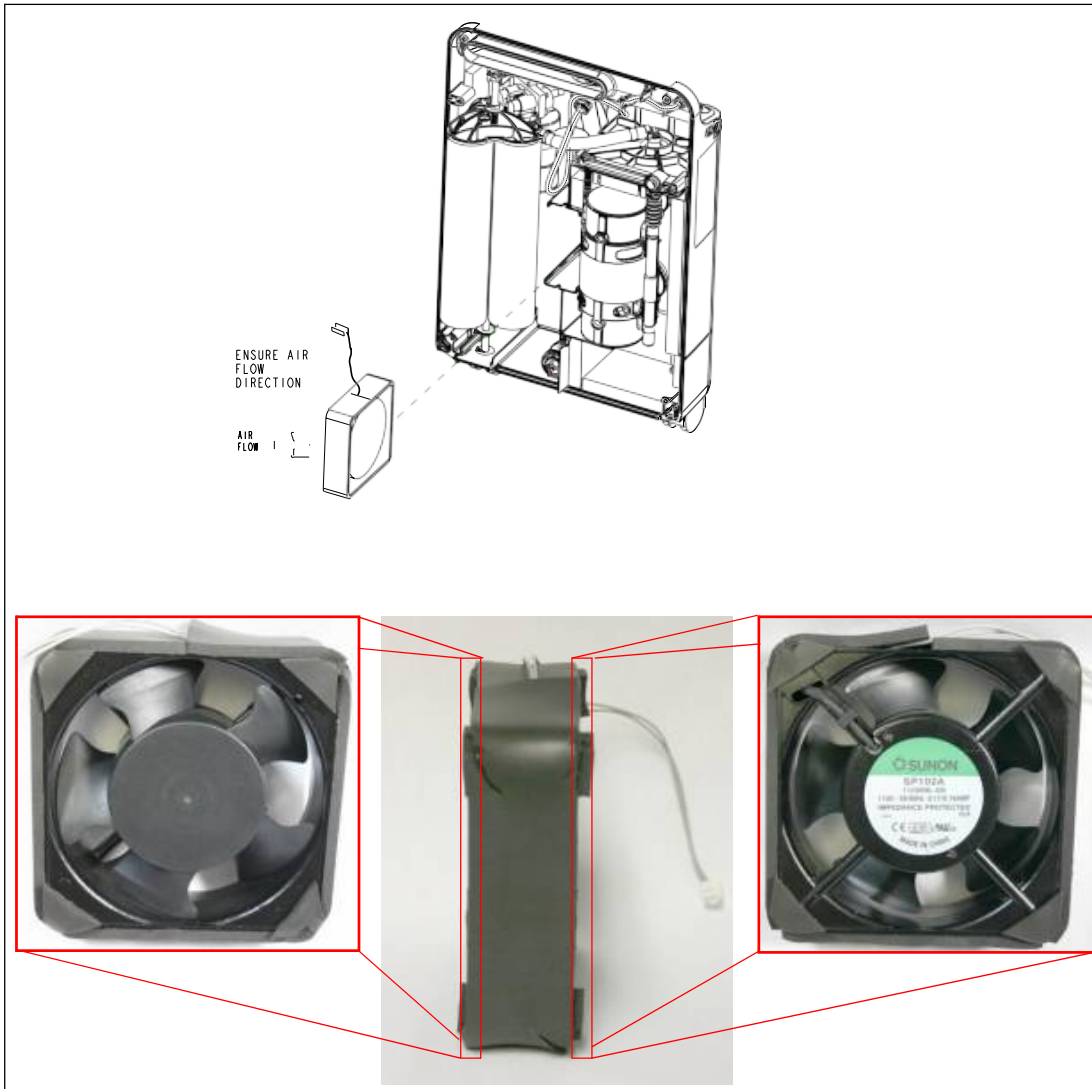

**Figure 8-21: FAN REMOVAL/INSTALLATION AND PROPER ORIENTATION**

2. Connect the Cooling Fan Connector to the J9 location of the Main PCA.
3. Secure the wires using the Cooling Fan wire clip.
4. Connect the Main PCA shield to the Front Cabinet locking tab.
5. Install the Rear Cabinet. Refer to the Rear Cabinet/Power Cord Replacement section for more information.
6. Install the Inlet Filter. Refer to the Inlet Filter Replacement section for more information.
7. Install the Filter Cover. Refer to the Filter Cover Replacement section for more information.

## 8.13 CAPACITOR REPLACEMENT

To remove the Capacitor

### CAUTION

1. Remove the Filter Cover. Refer to the Filter Cover Replacement section for more information.
2. Remove the Inlet Filter. Refer to the Inlet Filter Replacement section for more information.
3. Remove the Rear Cabinet. Refer to the Rear Cabinet/Power Cord Replacement section for more information.
4. Remove the two wires connecting the Compressor to the Capacitor.
5. Cut the tie wrap securing the Capacitor to the Front Cabinet.
6. Remove the Capacitor from the unit.

### To install the Capacitor

1. Place the Capacitor into the Front Cabinet.
2. Secure the Capacitor to the Front Cabinet with a tie wrap.
3. Connect the two black wires from the Compressor to the Capacitor.
4. Install the Rear Cabinet.
5. Install the Inlet Filter and Filter Cover.

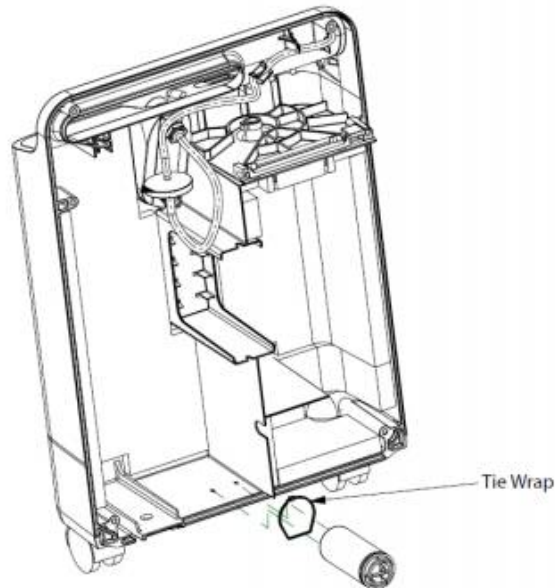

Figure 8-22: CAPACITOR REMOVAL/INSTALLATION

## 8.14 COMPRESSOR REPLACEMENT

### To identify the type of Compressor

1. Units equipped with the 0.38 Compressor can be identified by the “1098014” and “2450AE38” numbers on the Thomas label. This model compressor is not rated for Trans Fill models nor any units converted to TransFill capability.
2. Units equipped with the 0.44 compressor can be identified by “1020070” and “2450AE44” numbers on the Thomas label. This compressor should be used in all domestic TransFill units.



**Philips Compressor**



**GSSE Compressor**



**Thomas Compressor**

### To remove the Compressor

1. Remove the Filter Cover. Refer to the Filter Cover Replacement section for more information.
2. Remove the Inlet Filter. Refer to the Inlet Filter Replacement section for more information.
3. Remove the Rear Cabinet. Refer to the Rear Cabinet/Power Cord Replacement section for more information.
4. Remove the Main PCA. Refer to the Main PCA Replacement section for more information.
5. Remove the blue hose running from the Compressor to the Sieve Canister Assembly.
6. Cut the two tie wraps holding the mounting rod in place.

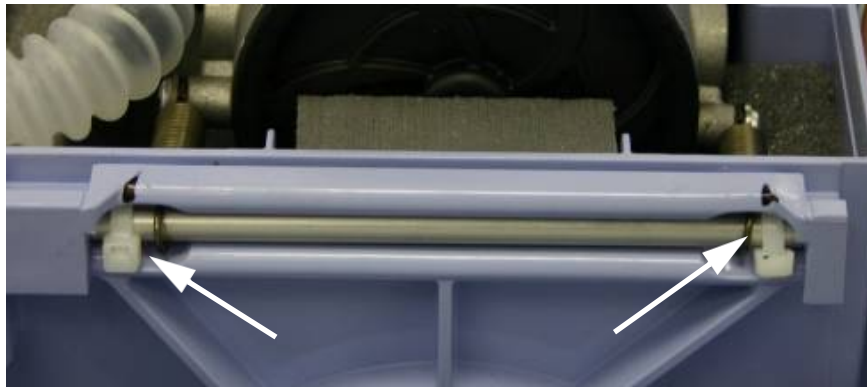

**Figure 8-23: MOUNTING ROD TIE WRAPS**

7. Remove the mounting rod securing the Compressor Springs to the Front Cabinet.



**Figure 8-24: MOUNTING ROD REMOVAL**

8. Disconnect the Compressor wires from the Capacitor.
9. Slightly lift the back of the compressor while threading the blue hose through the hole in the compressor mounting area in the Front Cabinet.



**Figure 8-25: COMPRESSOR REMOVAL**

10. Remove the Compressor from the Front Cabinet.

#### **To install the Compressor**

1. While routing the blue hose through the hole in the compressor mounting area, place the Compressor into the Front Cabinet.



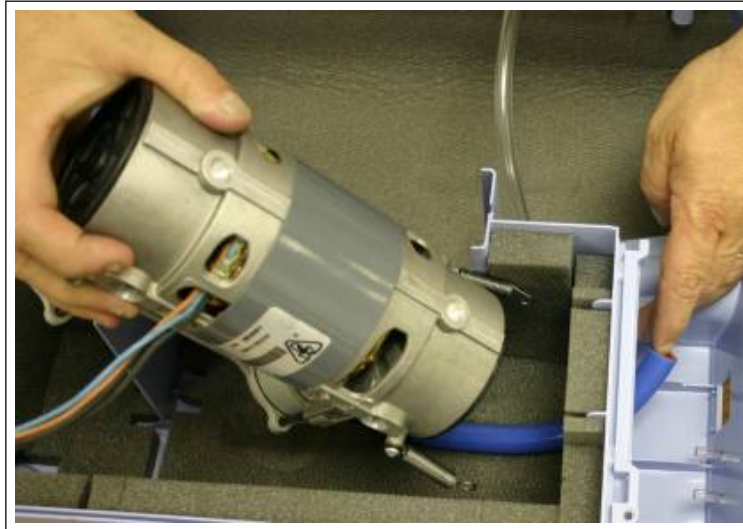

**Figure 8-26: COMPRESSOR PLACEMENT INTO FRONT CABINET**

2. Connect the blue hose to the Sieve Canister Assembly and secure it using a new one-eared clamp.
3. Connect the black Compressor wires to the Capacitor.
4. Place the Compressor springs in the grooves at the top of the Compressor Mounting area.
5. Lock the Compressor in place by sliding the mounting rod through the compressor springs and into place.
6. Install the Main PCA. Refer to the Main PCA Replacement section for more information.
7. Install the Rear Cabinet. Refer to the Rear Cabinet/Power Cord Replacement section for more information.
8. Install the Inlet Filter. Refer to the Inlet Filter Replacement section for more information.
9. Install the Filter Cover. Refer to the Filter Cover Replacement section for more information.

**NOTE**

The Philips Respironics manufactured compressors are not repairable and must be replaced.

**NOTE**

Devices manufactured after 06/18/2013 can be repaired with GSE Compressors. See Section 9.2 for RP Kit P/Ns. See Section 8.9 for a Serial No. cutoff for various EverFlo models. Devices originally equipped with short (11.5 inch) sieve canisters may not have the GSE compressor installed as a replacement.

**To replace compressor tubing and foam**

1. Remove the faulty blue tubing from the compressor outlet by cutting the clamp.



2. Install the replacement blue tube and attach the clamp with the hose clamp pliers. See assembled kit below.
3. Slide the protective plastic pipe over the blue tube all the way down to the hose clamp.
4. Attach the cable tie above the plastic pipe and trim the excess cable tie.
5. Install the foam in the compressor section of cabinet if the foam was not already installed as original equipment.

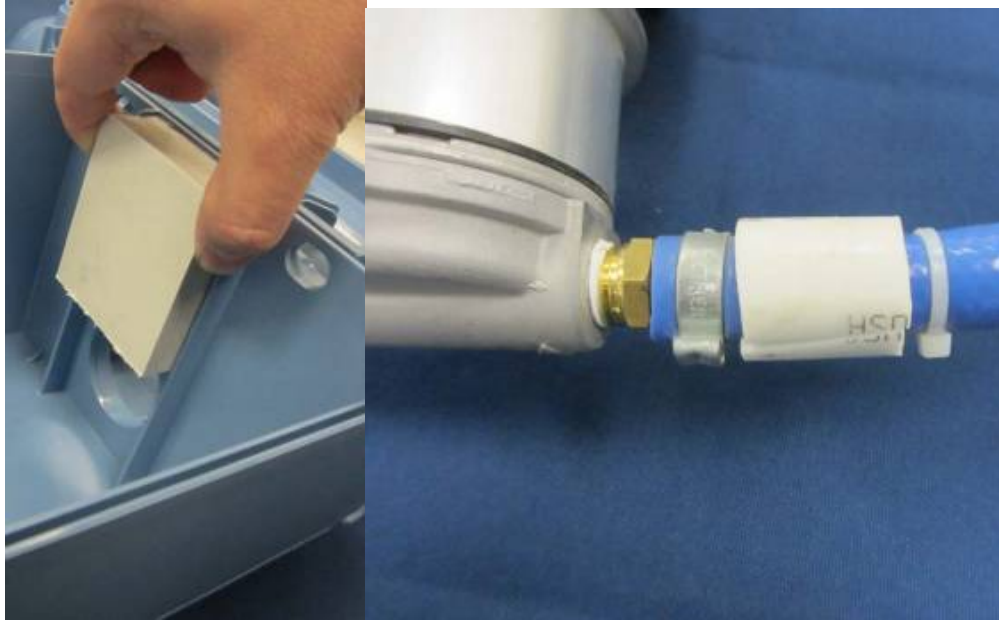

**Figure 8-27: Assembled Kit**

**To replace the Philips Respironics compressor's inlet tube assembly**

**NOTE**

The inlet tube assembly removal and replacement procedure detailed in this Procedure section is only applicable for Philips Respironics manufactured compressors.

**EverFlo Compressor Identification Table**

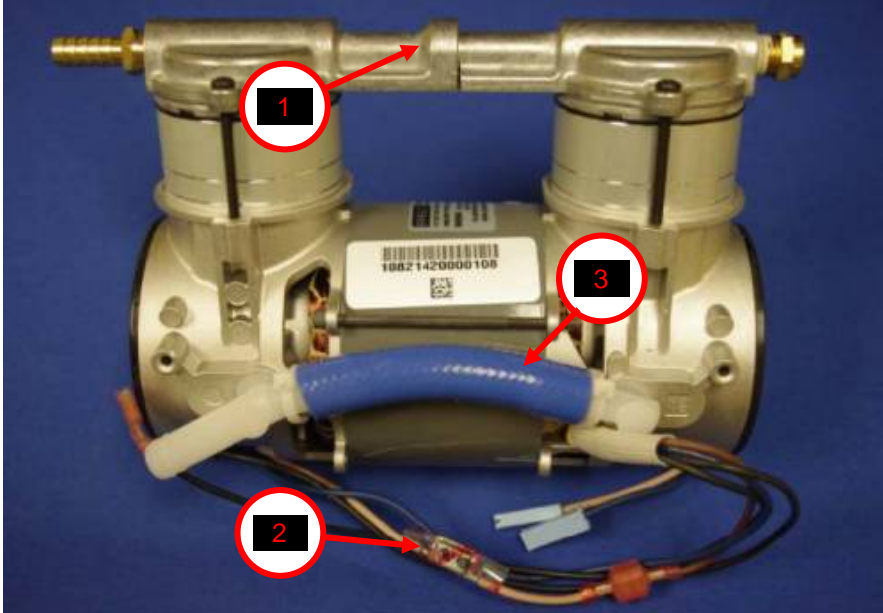
Compressor Manufacturer	Compressor Photo
<p><b>Philips Respirationics</b></p> <ol style="list-style-type: none"> <li>1. Two piece Valve Cover Assembly</li> <li>2. External thermal cutoff switch</li> <li>3. New inlet tube assembly design</li> </ol>	

**Inlet Tube Assembly Removal**

1. Remove the back cabinet of the EverFlo.
2. Inspect the EverFlo compressor for visible wear, deterioration, broken components, and service labels.
3. Make note of the manufacturer of the compressor by using the Compressor Identification table in the Detailed Description section of this field communication.
  - a. If the compressor is not manufactured by Philips Respirationics, this procedure is not applicable.
  - b. If the compressor is manufactured by Philips Respirationics, and the inlet tube assembly requires replacement, continue with this replacement procedure.
4. Remove the Philips Respirationics manufactured compressor from the EverFlo device.



5. Using side cutters, cut the two cable ties retaining the inlet tube assembly to the compressor housing.

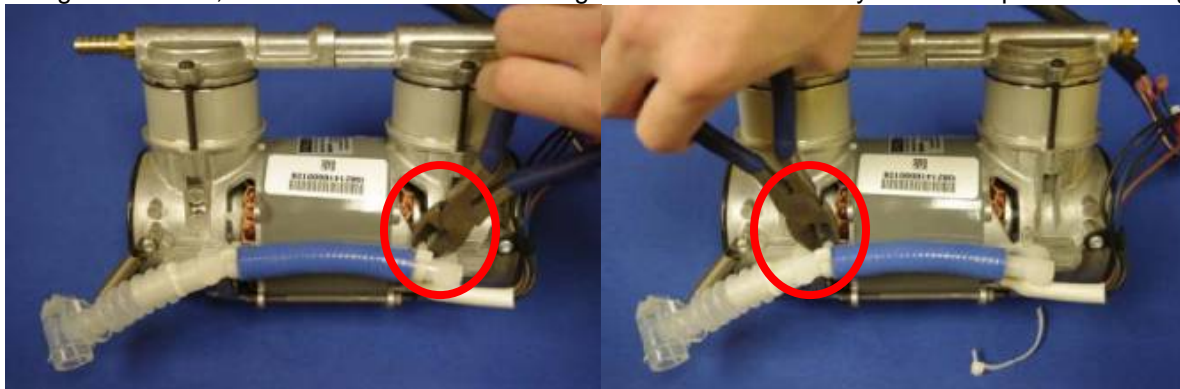

6. Gently pull the inlet tube assembly from the compressor housing. Discard the cut cable ties.

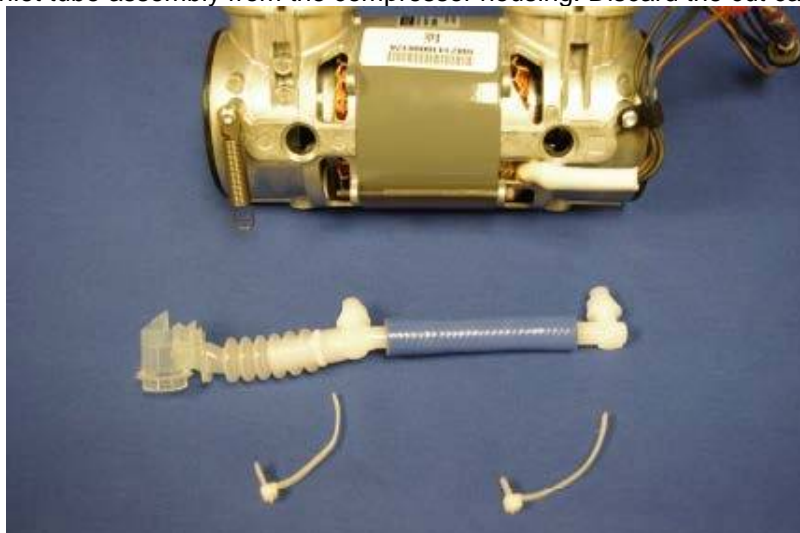

- Using side cutters, cut the cable tie securing the inlet boot bellows to the inlet tube assembly. Discard the cut cable tie.

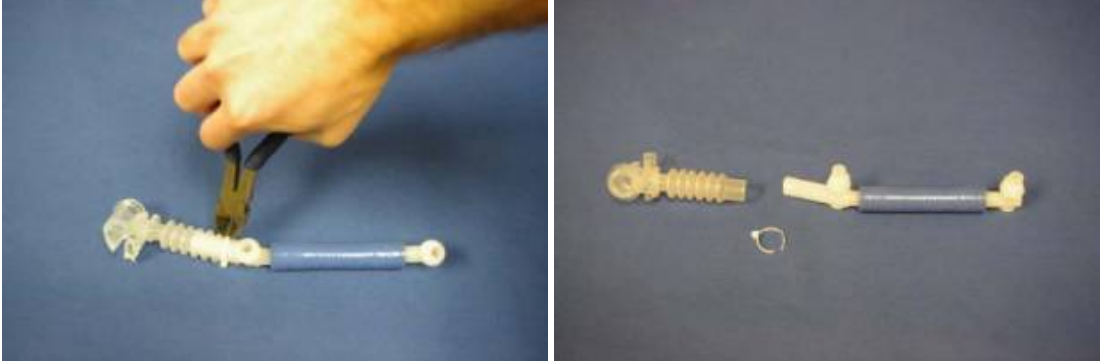

- Discard the used inlet tube assembly

**Inlet Tube Installation**

- Assemble the new inlet tube assembly by sliding the silicone tube over the tee and elbow connections. Ensure the center-to-center distance from elbow to tee is approximately 4.75 inches.

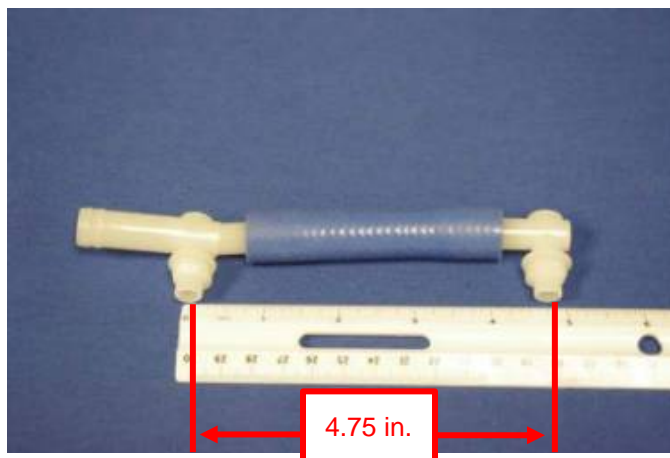
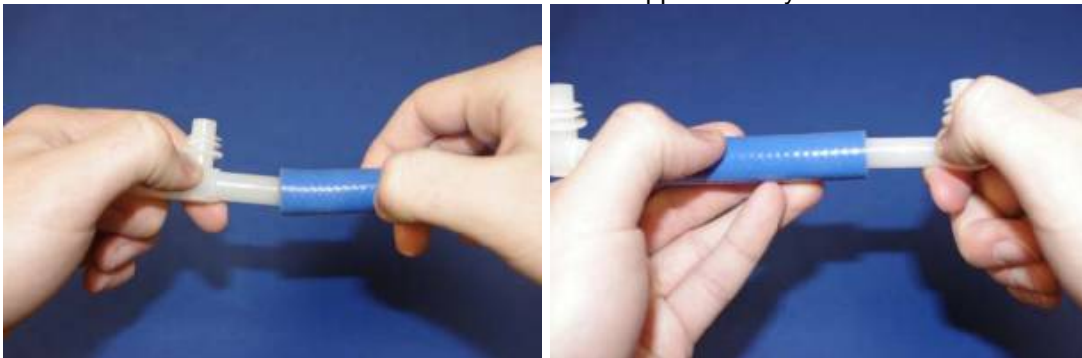

- Slide the inlet boot bellows (see Section 8.2) onto the tee. Secure with the included cable tie. Cut any excess cable tie and discard.



- Insert the inlet tube assembly into the compressor housing making sure to orient the inlet boot bellows on the same side of the compressor as the valve cover barbs.



- Secure the inlet tube assembly to the compressor housing by wrapping the two cable ties in the inlet tube assembly repair kit around the elbow and tee and through the compressor housing cutouts. Cut any excess cable tie using side cutters.





5. Install the compressor back into the EverFlo device.

## 8.15 MICRO-DISK FILTER & TUBING REPLACEMENT

### To remove the Micro-Disk Filter & Tubing

1. Remove the Filter Cover. Refer to the Filter Cover Replacement section for more information.
2. Remove the Inlet Filter. Refer to the Inlet Filter Replacement section for more information.
3. Remove the Rear Cabinet. Refer to the Rear Cabinet/Power Cord Replacement section for more information.
4. Remove the Flow Tubing from the DISS Outlet Fitting and the top connection of the Flow Meter.
5. Remove the Flow Tubing from the Micro-Disk Filter.
6. Remove the Pressure Tubing from the Pressure sensor located on the Main PCA (OPI Units Only).
7. Remove the other end of the Pressure Tubing from the bottom connection of the Flow Meter and from the Pressure Regulator (OPI Units Only).

### To install the Micro-Disk Filter & Tubing

1. Connect the Pressure Tubing to the Pressure Sensor located on the Main PCA (OPI Units Only).
2. Connect the Other ends of the Pressure Tubing to the Pressure Regulator and bottom connection on the Flow Meter. Refer to Refer to Figure 8-26.

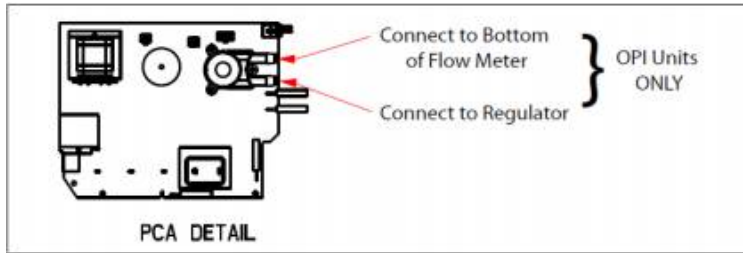

**Figure 8-28: PRESSURE TUBING CONNECTIONS**

3. Connect the Flow Tubing as shown in Refer to Figure 8-27.

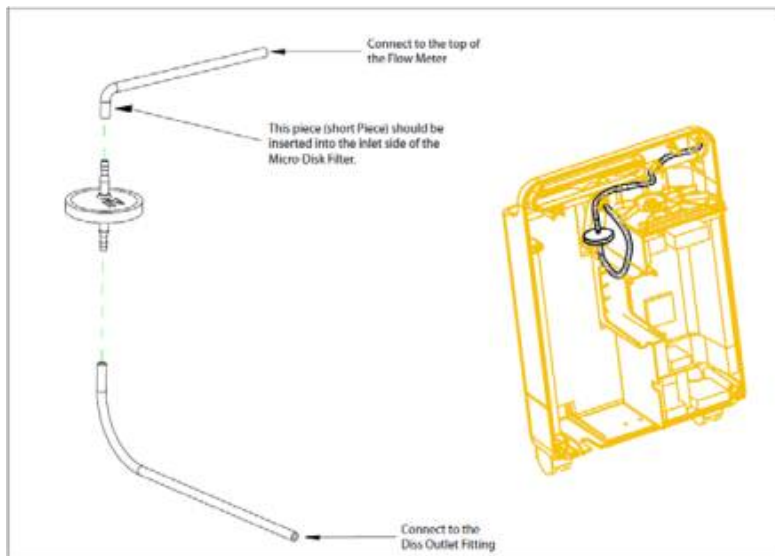

**Figure 8-29: FLOW TUBING INSTALLATION**

4. Install the Rear Cabinet. Refer to the Rear Cabinet/Power Cord Replacement section for more information.
5. Install the Inlet Filter. Refer to the Inlet Filter Replacement section for more information.
6. Install the Filter Cover. Refer to the Filter Cover Replacement section for more information.

## 8.16 FLOW METER REPLACEMENT

### To remove the Flow Meter

1. Remove the Filter Cover. Refer to the Filter Cover Replacement section for more information.
2. Remove the Inlet Filter. Refer to the Inlet Filter Replacement section for more information.
3. Remove the Rear Cabinet. Refer to the Rear Cabinet/Power Cord Replacement section for more information.
4. Remove the Tubing Connected to the Flow Meter.
5. Using pliers, loosen the two speed nuts from the threaded fitting on the back of the Flow Meter.
6. Remove the Flow Meter from the Front Cabinet.

### To install the Flow Meter

1. Align the threaded fittings on the back of the supplied Flow Meter with the holds in the Front Cabinet.

#### NOTE

2. While holding the Flow Meter in place, secure the Flow Meter to the Front Cabinet by hand tightening the two speed nuts.
3. Connect the pressure tubing to the fittings on the Flow Meter.



**Figure 8-30: FLOW METER REMOVAL/INSTALLATION**



## 8.17 FRONT CABINET REPLACEMENT

### To remove the Front Cabinet

1. Remove the Filter Cover. Refer to the Filter Cover Replacement section for more information.
2. Remove the Inlet Filter. Refer to the Inlet Filter Replacement section for more information.
3. Remove the Rear Cabinet/Power Cord. Refer to the Rear Cabinet/Power Cord Replacement section for more information.
4. Remove the Main PCA. Refer to the Main PCA Replacement section for more information.
5. Remove the Sieve Canister Assembly. Refer to the Sieve Canister Assembly Replacement section for more information.
6. Remove the Cooling Fan. Refer to the Cooling Fan Replacement section for more information.
7. Remove the Capacitor. Refer to the Capacitor Replacement section for more information.
8. Remove the Compressor Assembly. Refer to the Compressor Replacement section for more information.
9. Remove the Micro-Disk Filter and Tubing. Refer to the Micro-Disk Filter & Tubing Replacement section for more information.
10. Remove the Flow Meter. Refer to the Flow Meter Replacement section for more information.

### To install the Front Cabinet

1. Choose the correct EverFlo Label and place it in the appropriate spot on the front cabinet.

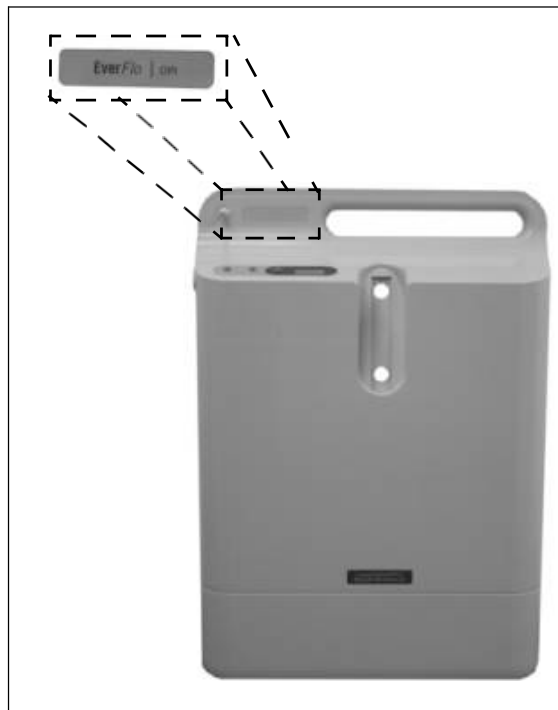

Figure 8-31: EVERFLO LABEL PLACEMENT

2. Print out two labels. One must include the serial label of the device and one must contain the model number of the device (see Section 8.19).

**IMPORTANT**

**NOTE**

**NOTE**

3. Place the two labels onto the Front cabinet and align with the clear section of the new Serial/Warning label included in the front cabinet repair kit. Refer to Figure 8-30.
4. Place the Serial/Warning label over the generic labels and onto the Front Cabinet in the proper location. Refer to Figure 8-30.

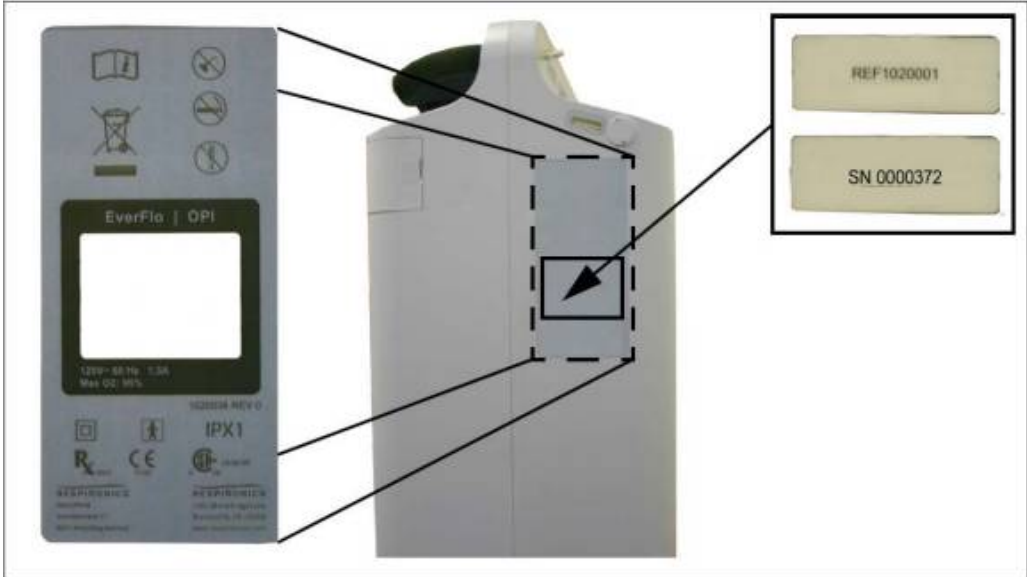

**Figure 8-32: NEW SERIAL/MODEL NUMBER LABEL PLACEMENT**

5. Install the Flow Meter. Refer to the Flow Meter Replacement section for more information.
6. Install the Micro-Disk Filter and Tubing. Refer to the Micro-Disk Filter & Tubing Replacement section for more information.
7. Install the Compressor Assembly. Refer to the Compressor Replacement section for more information.
8. Install the Capacitor. Refer to the Capacitor Replacement section for more information.
9. Install the Cooling Fan. Refer to the Cooling Fan Replacement section for more information.
10. Install the Sieve Canister Assembly. Refer to the Sieve Canister Assembly Replacement section for more information.
11. Install the Main PCA. Refer to the Main PCA Replacement section for more information.
12. Install the Rear Cabinet/Power Cord. Refer to the Rear Cabinet/Power Cord Replacement section for more information.
13. Install the Inlet Filter. Refer to the Inlet Filter Replacement section for more information.
14. Install the Filter Cover. Refer to the Filter Cover Replacement section for more information.

**To replace foam material stop**

1. Remove front cabinet
2. Remove any of the remaining original foam and adhesive from the cabinet. Use < 70% alcohol solution to remove residual adhesive.
3. Detach one of the foam stops from the RP Kit and remove the adhesive backing.
4. Attach the new foam stop in the same location as the original.

## 8.18 RETURNS / PACKAGING

### To package EverFlo

1. Assemble the packing carton and insert the base pulp part. Raise the right side of the base pulp part approximately 3 inches.



2. Insert the side pulp pack with the tab facing down and the hollow part facing the wall of the carton.
3. Press the side pulp pack part down until the base pulp part sits flat on the bottom of the carton.



4. Secure the casters with rubber bands.

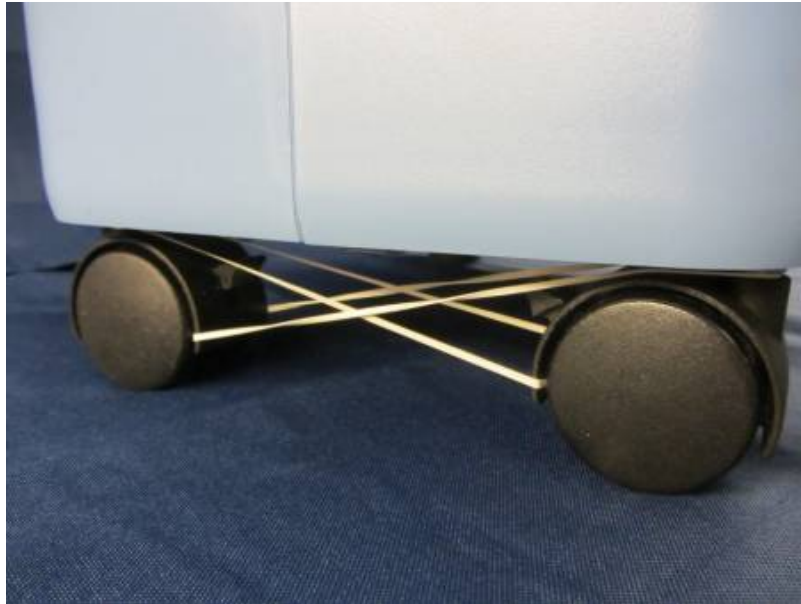

5. Place the EverFlo in the carton as per the diagram on the carton.



6. Place the left and right pieces of the pulp packing on the top of the EverFlo. The piece with the hole goes on the left side opposite the humidifier bottle rest.



- Order return pack RP kits to return faulty devices to Philips or reuse the original device packaging.

**To return Thomas compressors**

1. All Thomas EverFlo Compressors determined to be faulty during device servicing may be returned to Philips. See Section 8.2 for return packaging. Bulk kit users will use the return crates. GSE Compressors are not returned to Philips and should be disposed of locally.



## 8.19 LABELS

### UDI Labelling

Per the Unique Device Identification (UDI) initiative, medical devices are required to be labeled with certain device identifiers. The information provided on these labels allows the public to search and download information from the Global Unique Device Identification Database (GUDID) at AccessGUDID.

A UDI is a unique numeric or alphanumeric code that consists of two parts:

- a device identifier (DI), a mandatory, fixed portion of a UDI that identifies the labeler and the specific version or model of a device, and
- a production identifier (PI), a conditional, variable portion of a UDI that identifies one or more of the following when included on the label of a device:
  - the lot or batch number within which a device was manufactured;
  - the serial number of a specific device;
  - the date a specific device was manufactured;
  - the distinct identification code required by §1271.290(c) for a human cell, tissue, or cellular and tissue-based product (HCT/P) regulated as a device.

Devices that are currently out in the field and manufactured before September 24<sup>th</sup>, 2016 that are returned for repair, return to stock, conversion, or otherwise do not need to be relabeled with UDI compliant serial/model labeling. However, the device packaging will need to be updated to reflect UDI information.

Devices that are manufactured after September 24<sup>th</sup>, 2016 with a UDI compliant serial/model label and is converted to R/U from the base part number will not need new UDI serial/model labeling applied. However, a new UDI number will be assigned to the corresponding R/U part number for the packaging labeling.

Serial/model labels need to be replaced with UDI compliant labeling if the label has become illegible or the repair part where the serial label is applied requires replacement.

### **EQUIPMENT:**

Depending on which option is chosen, the printer used needs to ensure the barcode is legible and can be easily scanned. When reprinting a 2D barcode, a higher resolution, 300 DPI or higher, printer may be necessary.

The following printer (or equivalent) is recommended:

Zebra GX430T or similar printer specifications:

- Label printer
- monochrome
- direct thermal / thermal transfer
- Roll (4.25 in)
- 300 dpi
- up to 240.9 inch/min
- USB
- LAN
- serial



**RECOMMENDED SOFTWARE:**

- Loftware Software & Print Key (Fees Apply)
  - For a full detailed list of Loftware supported printers and fees, please refer to: [http://www.loftware.com/support/tech\\_printers.cfm](http://www.loftware.com/support/tech_printers.cfm)
  - For software support, visit their website at [www.loftware.com](http://www.loftware.com)

**ACTION TAKEN**

Each label being replaced will need to display:

- Reference (model) Number (e.g. 1068693)
- UDI Information: Choose 1 of 3 options listed below
- Serial Number (e.g. 200001)
- Original Manufacturing Date (e.g. 2016-02-29)
- Country of Origin, if necessary

There are three (3) different options available for reprinting the serial number label, as seen in the figure below.

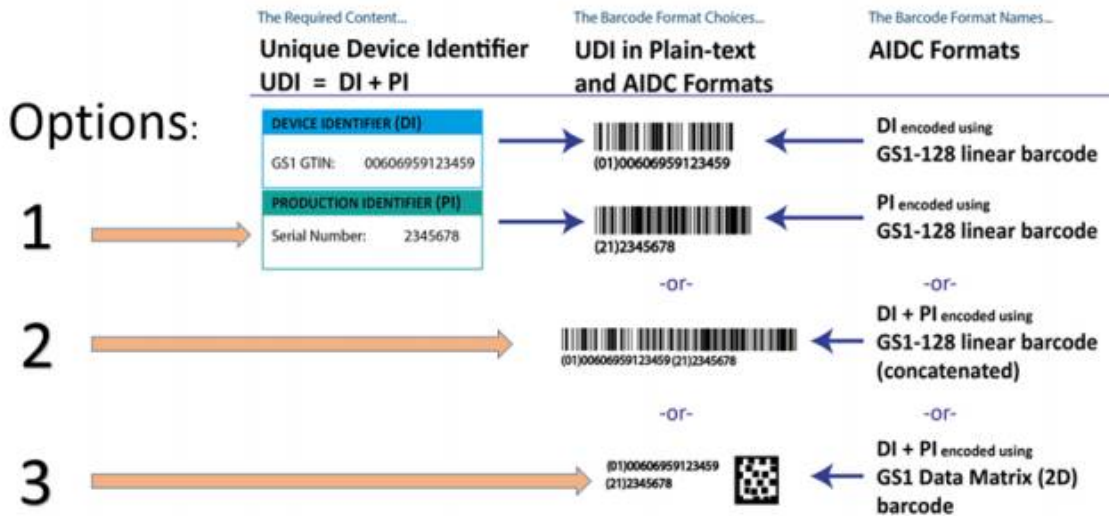

**PROCEDURE:**

1. Print a UDI compliant serial/model number label in accordance with the specifications detailed above.
2. Apply the new label to the product in the same location as the original label.
3. Place a clear overlay over the label, if necessary.

## Chapter 9. TESTING

### 9.1 LONG LIFE FILTER TEST

This following test can be performed to determine if the EverFlo Long Life Filter has become restricted.

#### 9.1.1 TESTING PROCEDURE

1. Power up the EverFlo Concentrator and set the flow to 5LPM.
2. Run the device for 10 minutes
3. Measure and record the Oxygen Concentration (1st Reading).
4. Remove the Door and the Long Life Filter from the concentrator.
5. Wait approximately 3 minutes.
6. Measure and record the Oxygen Concentration (2nd Reading).
7. If the 2nd Oxygen Concentration reading is greater then 2.0 from the 1st Oxygen Concentration reading, the Long Life Filter needs replaced.

### 9.2 EVERFLO SYSTEM FINAL TEST

The following test must be performed after any repairs to the EverFlo Oxygen Concentrator. The results of the test must be entered on the Testing Data Sheet provided and signed, in ink, and dated by the technician performing the test.

This test may also be used as a performance verification procedure on the unit between patient usages.

#### 9.2.1 TEST EQUIPMENT



#### NOTE

- Concentrator Tool Kit (H647)
- Calibrated Oxygen Analyzer
- Test Flow Meter for EverFlo UltraFill Compatible Devices (Assemble Pieces as shown below)
  - 1/8" NPT Coupling Insert (1)
  - Brass 1/8" NPT Male to Female Adapter (2)
  - Flowmeter (3)
  - Orifice (0.038") (4)

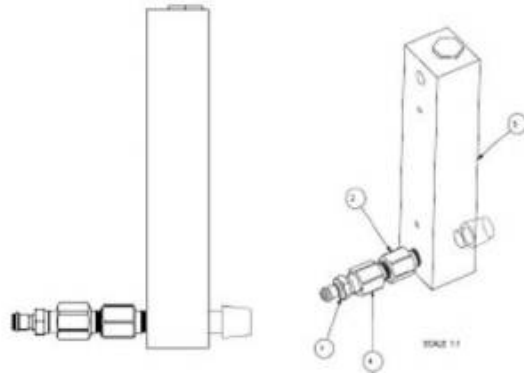

**Figure 9-1: TEST FLOWMETER ASSEMBLY**

**9.2.2 TESTING PROCEDURE**

1. Ensure that the unit has been run-in for a minimum of 1 hour.
2. Record the serial number and model number located on the side of the unit, in the space provided on the Testing Data Sheet.
3. Record the voltage and frequency at which the unit is being tested.
4. Record the hours from the hour meter after the Device has finished its 1 hour run in on the Test Data Sheet.
5. Verify the flow meter is set to 5 LPM. If a pediatric flow meter is installed, verify the flow meter is set to 1.0 LPM. Connect the test gauge to the outlet barb. Measure the outlet pressure. The outlet pressure should be within 5.0- 7.0 psig. Record the results. On the test data sheet, circle Yes or No for pediatric flow meter. If testing a device with a pediatric flow meter installed, the “No Flow Alarm” feature is not available, remove the pressure gauge from the outlet barb and proceed to step 7.
6. With the pressure gauge still connected to the outlet, the flow meter ball will drop down to zero (0) LPM. Within 120 seconds (160 seconds for EverFlo T models) the “No Flow” alarm will sound and the yellow LED (Low Oxygen) will illuminate. Record the results. Remove the pressure gauge from the outlet barb.
7. Set the flow meter to two (2) LPM (for units equipped with pediatric flow meters set the flow to 0.1 LPM). Connect a calibrated oxygen analyzer to the outlet barb, measure and record the oxygen concentration. Set the flow meter to five (5) LPM (for units equipped with pediatric flow meters set the flow to 1 LPM). Measure the oxygen concentration. Record the results. For OPI devices proceed to step 8. For non OPI devices proceed to step 9.
8. Verify that the OPI is working properly by observing that the red or yellow LEDs are NOT illuminated and the oxygen concentration is above 90% for the following model numbers:

1020001	1020009	1020013	1039364
1020002	1020010	1020014	1039365
1020004	1020011	1039362	
1020006	1020012	1039363	

Above 87% for model numbers 1020007 and 1020008, record the results.

9. Disconnect the oxygen analyzer and tubing from the outlet of the concentrator. For EverFlo UltraFill Compatible devices set the concentrator to 1-3 LPM. Proceed to Step 10. For all other EverFlo devices proceed to Step 14.
10. Connect the Test Flowmeter to the UltraFill port, located on the side of the EverFlo.



11. Open the Test Flowmeter flow knob 3-4 turns.
12. Wait at least 1-3 seconds.
13. Read the Test Flowmeter value. Record the results. If the flow is greater than 10 SLPM the unit **PASSES**.
14. In ink, fill out the rest of the Test Data Sheet after all tests have been completed. If the unit has failed any of the tests performed, the unit must be repaired and retested according to released documentation.

**9.3 EVERFLO TEST DATA SHEET**

**NOTE**

All information on this data sheet should be entered in the correct location after the associated test was completed. The data sheet must then be signed in ink and dated by the technician performing tests. Circle "Pass" or "Fail". Leave all unused boxes blank.

**Step 2** Serial Number: \_\_\_\_\_ **Step 3** VAC: \_\_\_\_\_ Hz: \_\_\_\_\_ **Step 4** Hour Meter: \_\_\_\_\_

Model Number: \_\_\_\_\_

**Step 5**

<b>Oxygen Outlet Pressure 5.0 - 7.0 psig</b>		<b>Pediatric Flow Meter</b>	<b>Yes</b>	<b>No</b>
--	--	-----------------------------	------------	-----------

**Step 6**

<b>No Flow Alarms &lt; 120 sec. EverFlo T Devices &lt; 160 sec.</b>	<b>Pass</b>	<b>Fail</b>	
---	-------------	-------------	--

**Step 7**

<b>Flow Meter Oxygen Concentration (Pediatric Flow Settings)</b>	<b>EverFlo Models</b>		<b>1020007 and 1020008</b>	
	<b>90-96% @ 2 LPM 90-96% @ 5 LPM</b>		<b>87-96% @ 2 LPM 87-96% @ 5 LPM</b>	
	<b>2 LPM (0.1LPM)</b>	<b>5 LPM (1LPM)</b>	<b>2 LPM (0.1LPM)</b>	<b>5 LPM (1LPM)</b>

**Step 8**

**Step 13**

<b>OPI Verification</b>	<b>Pass</b>	<b>Fail</b>	<b>O2 Coupler Flow &gt; 10 SLPM</b>	<b>Pass</b>	<b>Fail</b>
-------------------------	-------------	-------------	-------------------------------------	-------------	-------------

Signature: \_\_\_\_\_ Date: \_\_\_\_\_ Notification Number: \_\_\_\_\_  
(PRI internal use Only)

Print Name \_\_\_\_\_ Asset Numbers \_\_\_\_\_ / \_\_\_\_\_  
(PRI internal use Only)

## Chapter 10. TOOLS AND EQUIPMENT

You should have the following hand tools and supplies available for troubleshooting, testing, and repairing the EverFlo Concentrator.

<b>Common Hand Tools</b>
Antistatic, Electro-Static Discharge (ESD)-protected work station - minimum requirement is a grounded mat and wrist strap
Phillips Screwdriver - medium (included in H646 Tool Kit)
Phillips screwdriver, size "00"
5/16" Hex Driver (5/16" bit included in H646 Tool Kit)
6 inch long 5/16" Hex Driver Bit Kit
9/16" Open-end wrench
9/16" Socket
Heyco Pliers
Torque Wrench 1.5 in-lbs.
Torque Wrench 8 in-lbs.
Torque Wrench 25 in-lbs.
Torque Wrench 35 in-lbs.
Torque driver 1-2 INLBS range with T6 bit.
Fuse Extractor
Concentrator Tool Kit (H647)
Diagonals (wire cutters)
Needle Nose Pliers (insulated)
Channel Locks (medium)
One Ear Clamp Pliers
Pressure Gauge

<b>Equipment</b>
Digital Multimeter
Calibrated Oxygen Analyzer
1/8" NPT Coupling Insert (Colder P/N MC2402 or equivalent)
Brass 1/8" NPT Male to Female Adapter (McMaster-Carr P/N 9171K610 or equivalent)
Flowmeter (Dwyer P/N VFB-67-SSV or equivalent)
Orifice 0.038" (McMaster-Carr P/N 2712T482 or equivalent)
Oxygen Interface Hardware Kit (see Section 8.2)

**Supplies**

Cleaning Cloth

Mild Detergent

**10.1 ACCEPTABLE TEST EQUIPMENT****10.1.1 DIGITAL MULTIMETER****Specifications**

- 3 1/2" digital readout

**Acceptable Options**

- Fluke 87 or better model
- Any commercially available digital multimeter that meets the above specification.

**10.1.2 OXYGEN ANALYZER****NOTE****Specifications**

- Range: 0.0% to 100% O<sub>2</sub>
- Accuracy +/- 2.0% O<sub>2</sub>

**Acceptable Options**

- MSA MiniOX I-CE Oxygen Analyzer

Any commercially available calibrated Oxygen Analyzer that meets the above specifications.

## Chapter 11. SERVICE SOFTWARE

### 11.1 EVERFLO SERVICE TOOL

#### 11.1.1 Required Equipment

Description	Version
Oxygen Interface RP Kit	N/A
Laptop/Desktop PC with Windows 7 Operating System (32/64 bit) or Windows 10 Operating System.	N/A
EverFlo Service Tool Installer	2.0.0.1
EverFlo Service Manifest File	1.0.3

#### 11.1.2 Download and Installation

1. Log into my.respironics.com
2. Select "Service Software and Documentation"

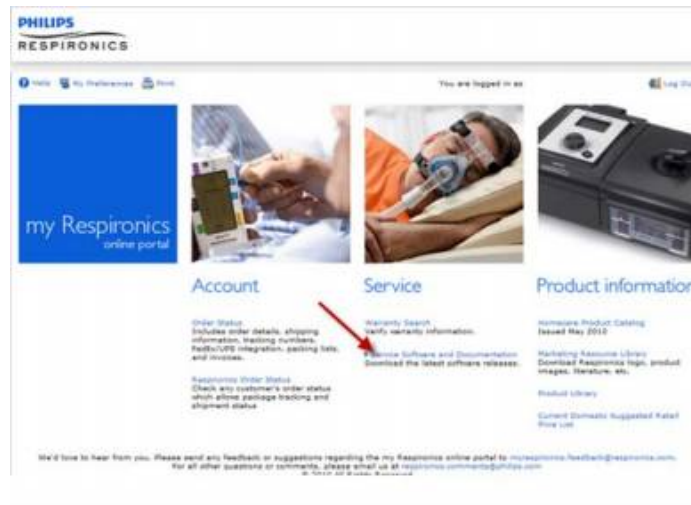

3. Select *EverFlo Service* from the Service Software Category list





- 4. Download the software and follow the on screen instructions in regards to file location.
- 5. Install the EverFlo Service Tool

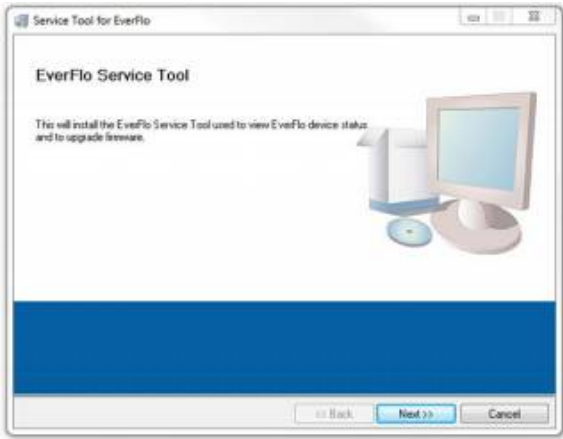

- 6. Allow the program to install to the default location

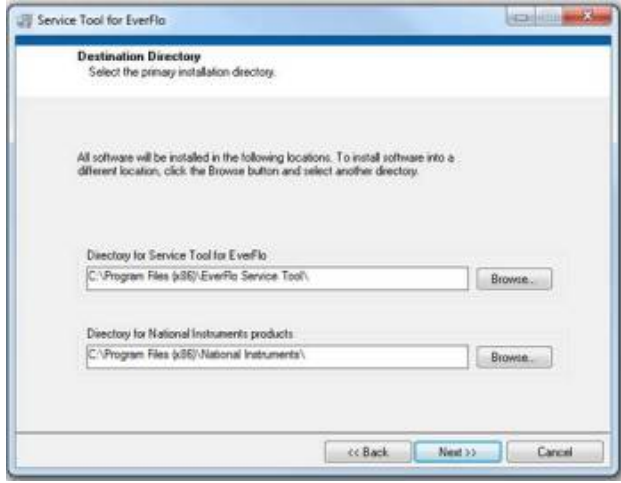

- 7. Agree to the legal licenses and click *Next*.
- 8. A couple status bars will show the progress of the download

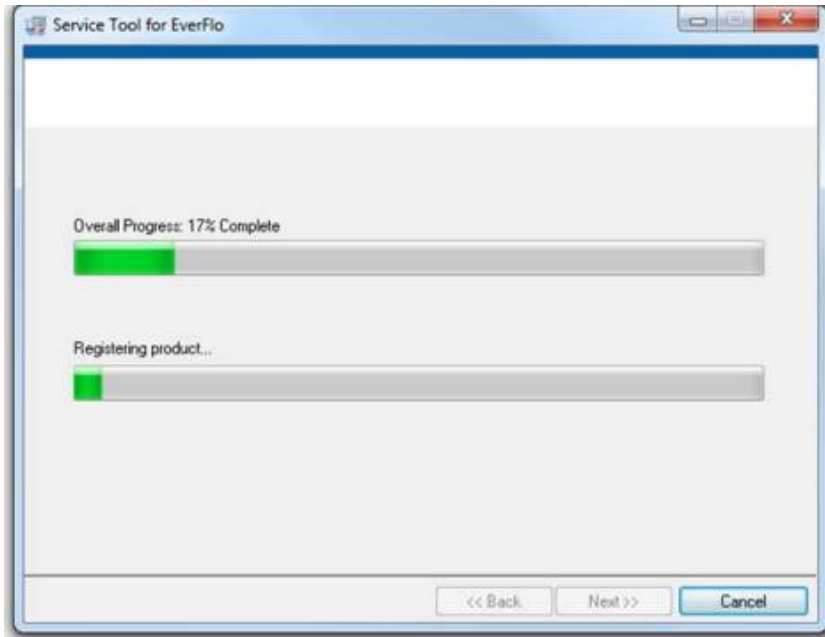

- 9. The installer will indicate the status of the Service Tool installation.
- 10. Click the *Extract* button to install the current version driver of the FTDI drivers



11. Click the *Next* button and continue with the procedure

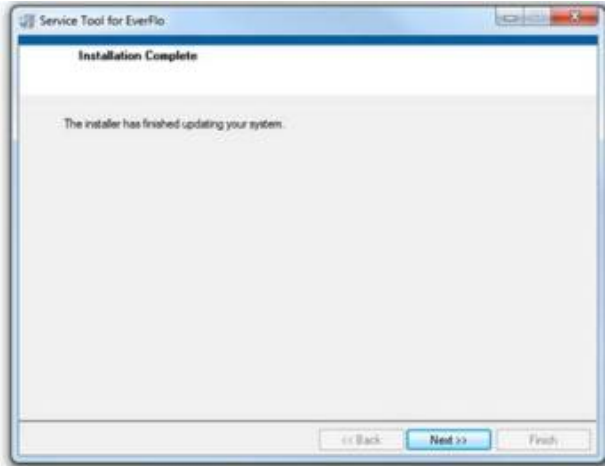

12. Click the *Finish* button once the installer finishes loading the software. Users will be prompted to restart their computer. See screenshot below



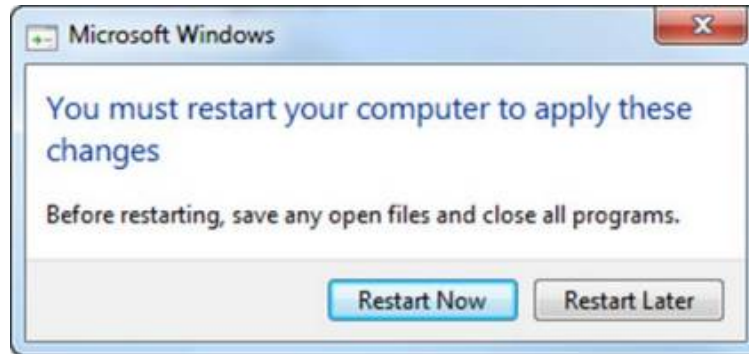

- 13. Repeat step 1-3 to load the Manifest ZIP file from my.respironics.com.
- 14. Then unzip file into location where EverFlo Service Upgrade tool was installed. For example:  
C:\Program Files (x86)\EverFlo Service Tool.

**11.1.3 Context Definitions for Main Screen:**

Click on the "Help" tab and select the "About" option. This will display the Service Upgrade Tool flash screen



- 1. Enter Device manager and set the COM port advanced settings to the proper latency setting.

**11.1.4 COMMUNICATION PORT SETTINGS:**

1. Connect the Oxygen Interface kit to the computer USB port.
2. Once the Communication Port has been assigned/ established to communicate with the EverFlo, locate the My Computer Icon on the computer Desktop or through Windows start menu.
3. Using the mouse, right *click* on My Computer and select Properties.
4. Select the Hardware tab and then the Device Manager Link.
5. Select the Ports drop down arrow, locate and right *click* the USB serial port, and select Properties.
6. Select the Port Settings tab and then select the *Advanced* button.
7. Locate and select the Latency Timer drop down arrow and select a setting of 1.
8. Select the Ok button when applicable and then close all windows.
9. Open the software by clicking the icon on the desktop and select the proper COM port.



10. Connect the Interface USB cable to the computer and connect the Mini-DIN to the EverFlo.
11. The main screen will open and will display the EverFlo Service Tool.

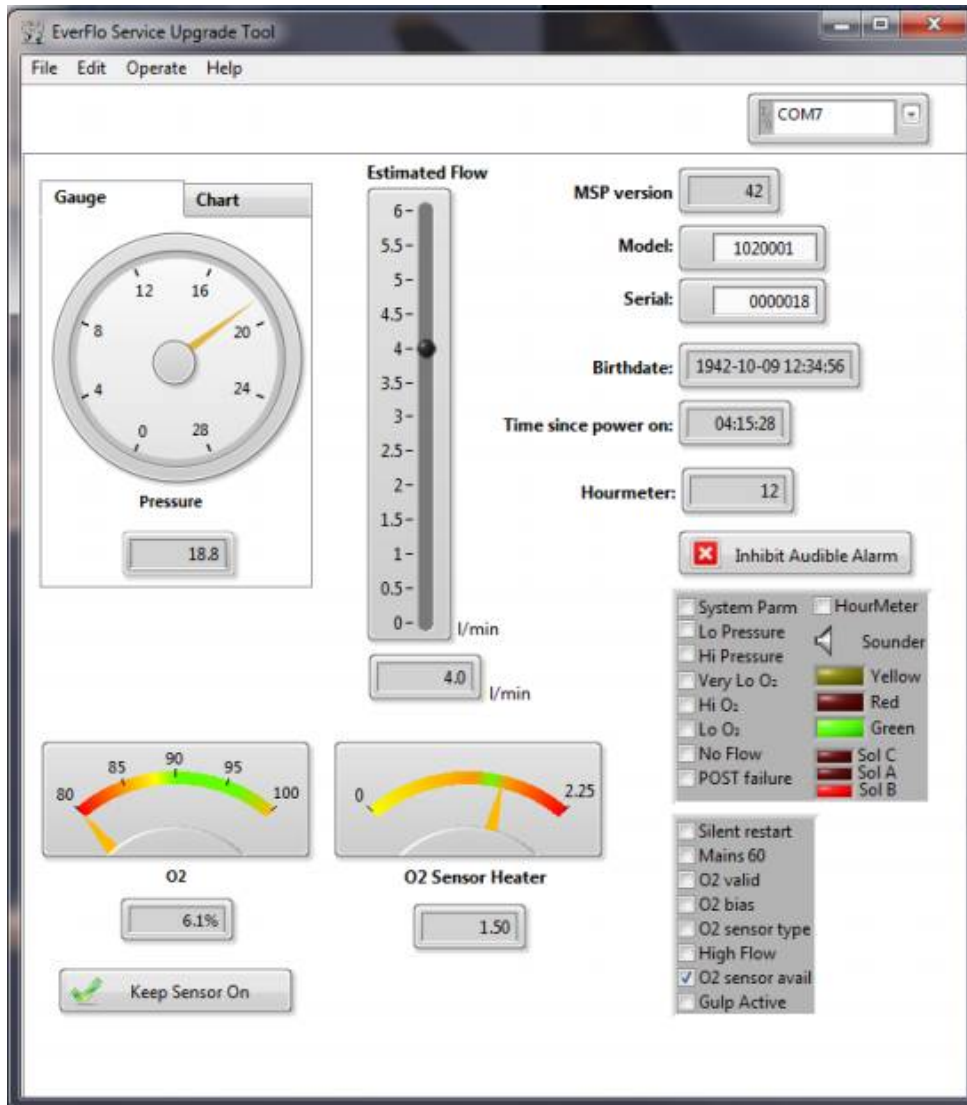

Feature	Definition
Gauge and Chart	Pressure measurement of the product tank in PSI Used to measure the balance and peak pressure. To be used to check the sieve canister balance. 15-27 PSI range
Estimated Flow	Estimation of flow rate in liters per minute from EverFlo product tank, derived from the pressure slope.
Serial ID, Birthdate, Time, Model	Factory supplied identifier and date/time from the flash memory. Internal timer which resets to zero when the device is reset or powered off. Model number and Serial Number are enabled for edits to the PCA based on the device label.

Inhibit Audible Alarm	Alarm silence
O2 Gauge	Oxygen purity reported by the internal OPI sensor. OPI devices only.
Keep Sensor On	OPI sensor remains on as long as the device is turned on.
MSP version	Firmware version of the MSP microcontroller: Currently released manufacturing firmware is 3.0 and will show as 30 in the MSP version box. 4.2 will show as 42 in the version box.
O2 Sensor Heater	Oxygen sensor heater power gauge
Estimated Flow	The device computed flow from the PCA.
Hour Meter	This field is now enabled to input hours from the device hour meter. Used to transfer the hours from the analog hour meter into the LCD hour meter.

**11.1.5 EverFlo Service Tool information:**

<b>Definitions Of The Lower Check Box Section</b>	
Silent Restart	TRUE if a silent restart is in progress.
Mains 60	TRUE if AC mains frequency detection reports 60 Hz.
O2 Valid	TRUE if O2 sensor output is considered valid.
O2 bias	TRUE if the O2 sensor bias is enabled.
Pin 5.7	(Not used for Service.)
High Flow	TRUE if high flow alarm condition is active
Gulp Active	TRUE if the EverFlo is TransFill Enabled and actively supplying a TransFill device.

**11.1.6 Table for the Device Alarms Box:**

<b>Definitions Of The Higher Check Box Section: Alarms</b>	
System Parm	If checked, the memory consistency check of the parameter memory has failed.
Lo Pressure	If checked, product canister pressure has remained below the low pressure threshold.
Hi Pressure	If checked, product canister pressure has remained above the high pressure threshold.
Very Lo O2	If checked, product O2 purity has remained below the Very low O2 threshold. Red light alarm
Hi O2	If checked, product O2 purity has remained above the High O2 threshold and the O2 Sensor has stopped working.
Lo O2	If checked, product O2 purity has remained below the low O2 threshold, but above the Very Low O2 threshold.
No Flow	If checked, output flow has been determined to be at or near zero flow.
POST failure	If checked, a power on self-test failure occurred.
Hour Meter	Checked, when the elapsed hour indicator discrete output is being pulsed.
Sounder	Active when the audible alarm discrete output is driven active.

Yellow	Illuminated when the yellow LED is active.
Red	Illuminated when the red LED is active.
Green	Illuminated when the green LED is active.
Sol C	Illuminated when solenoid valve C is active and the device is equipped with a Purge valve.*See Note below
Sol A	Illuminated when solenoid valve A is active.
Sol B	Illuminated when solenoid valve B is active.

**11.1.7 Content Definitions for Upgrade Firmware:**

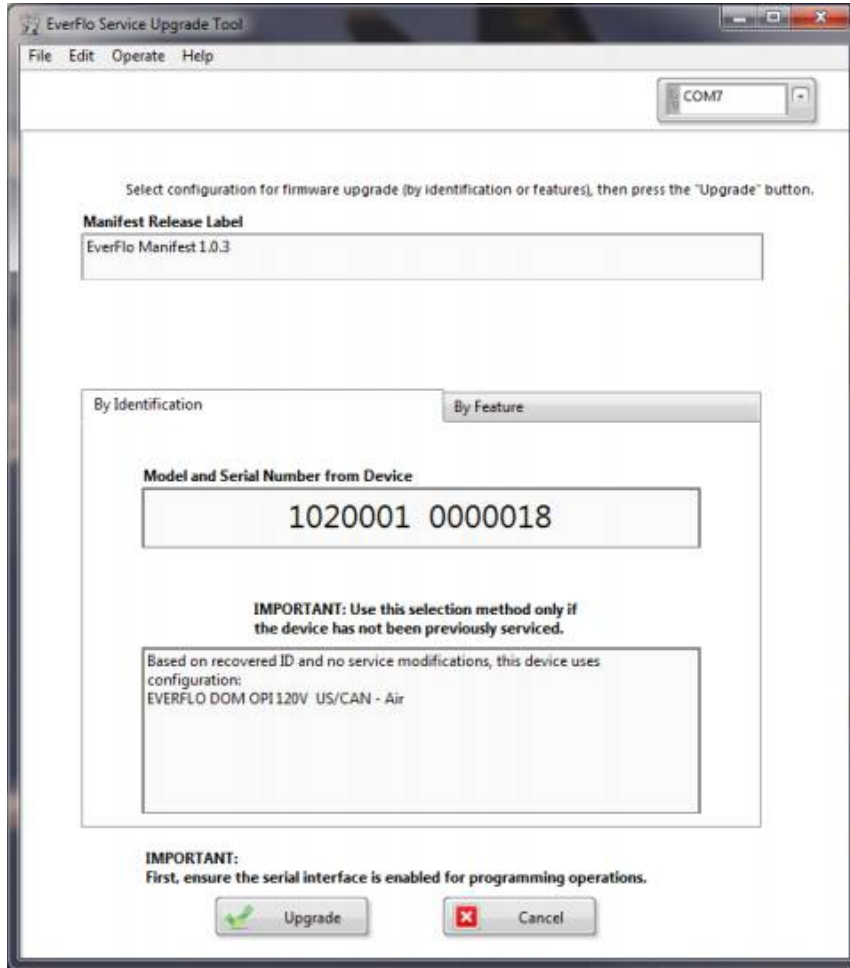

**IMPORTANT NOTE**

**MODEL NUMBER AND SERIAL NUMBER ARE ENABLED FOR EDITS TO THE PCA BASED ON THE DEVICE LABEL. MUST BE NAMED TO LOAD FIRMWARE**



<b>Feature</b>	<b>Definition</b>
Firmware Upgrade	By Identification from the PCA or By Feature of the parts contained in the EverFlo.
By Identification	Model and serial number imprinted on the PCA and read by the Service Tool
By Feature	Model type, Compressor and Solenoid valve type the unit is equipped with. A single known configuration must be found in order to upgrade the Firmware.
Upgrade	Execute button to load firmware. The unit will alarm until the firmware installs.
COM Port	Selects the available serial port for the EverFlo
Manifest Release Label	Identification of the released version of the manifest file.
Cancel Button	Cancels the upgrade process without installing the firmware and returns to the main screen.

**NOTE**

This EverFlo Service Tool is intended to be used for the EverFlo devices only. Damage and functionality loss will result if this Software is used on other Respironics products.

**11.1.8 Upgrade Procedure:**

**NOTE**

This Service Upgrade Tool is not to be used on units equipped with a purge valve assembly. Installing 3.0 Software will cause the purge valve to no longer function. See EverFlo 230 VAC New Spare Parts,17-04-09

1. All devices returned to for Service are recommended to have its firmware checked and upgraded as needed.

**IMPORTANT NOTE**

**EverFlo devices with PCAs equipped with an LCD hour meter will use firmware 4.2. EverFlo devices with PCAs equipped with an Analog hour meter will use firmware 3.0.**

2. Open the program from the desktop or program list.
3. Connect the Oxygen Interface Kit to the COM port on the computer that is used by this program.
4. Set the Interface Kit to the Program Mode by sliding the switch to the left.
5. Turn on the EverFlo and remove the Mini DIN cover.
6. Connect the Interface Kit to the Mini DIN connection on the EverFlo near the Hour Meter.
7. Select the COM port the EverFlo is connected to.
8. The EverFlo Service Tool will begin to downloading the information from the EverFlo and bring up the Main Screen.

9. Verify the MSP software version is the most current. If not the most current version, then continue with the Upgrade process.
10. Select the *File* and then the *Upgrade Firmware* option.

**NOTE**

If the Upgrade Firmware option is unavailable, the Manifest file has not been properly loaded.

11. If the PCA is original to the unit, the model number and serial number will match the device label and show up in the *By Identification* box. See Note below. If not, then proceed to step:18

**NOTE**

The technician must determine that the device is completely original and has not been serviced previously. If the unit was serviced in the past then upgrade the firmware **By Feature Only**. PCAs equipped with LCD hour meters require upgrading via the **By Feature** method.

12. Upgrade when a single known configuration shows in the bottom box.
13. Click the *Upgrade* button and the EverFlo will alarm as the firmware is installed.
14. Click the *Print* button to print an Upgrade Record form. Print Function: see with an example of the Upgrade Record. The technician is required to fill out the information on the form and keep it with the Service paperwork (**Only Chance to Do This**)



15. Click the *OK* button to return to the main screen.

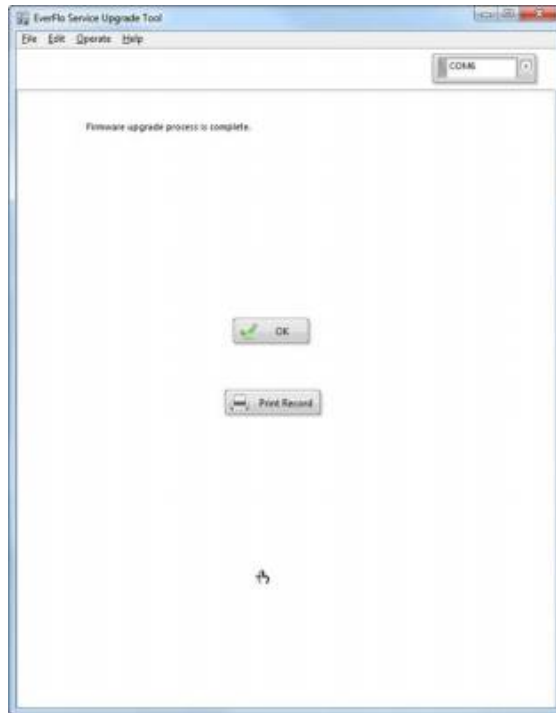

16. The Service Tool will reload the information and the main screen will display.
17. The MSP version will be changed to the current release of firmware and is complete.
18. Upgrading by feature is used if the PCA was replaced in the past and PCA serial number and model number do not match the device label. The technician must inspect the unit for the required components such as the device model number, compressor type and solenoid valve type
19. Reference Field Communications for additional information on configurations and serial number cutoffs. The model number and serial number must be updated to show the model number and serial number from the device label and enter that information in the fields on the main screen

---

<b>MSP version</b>	<input type="text" value="42"/>
<b>Model:</b>	<input type="text" value="1020001"/>
<b>Serial:</b>	<input type="text" value="0000018"/>
<b>Birthdate:</b>	<input type="text" value="1942-10-09 12:34:56"/>
<b>ince power on:</b>	<input type="text" value="05:22:08"/>

---

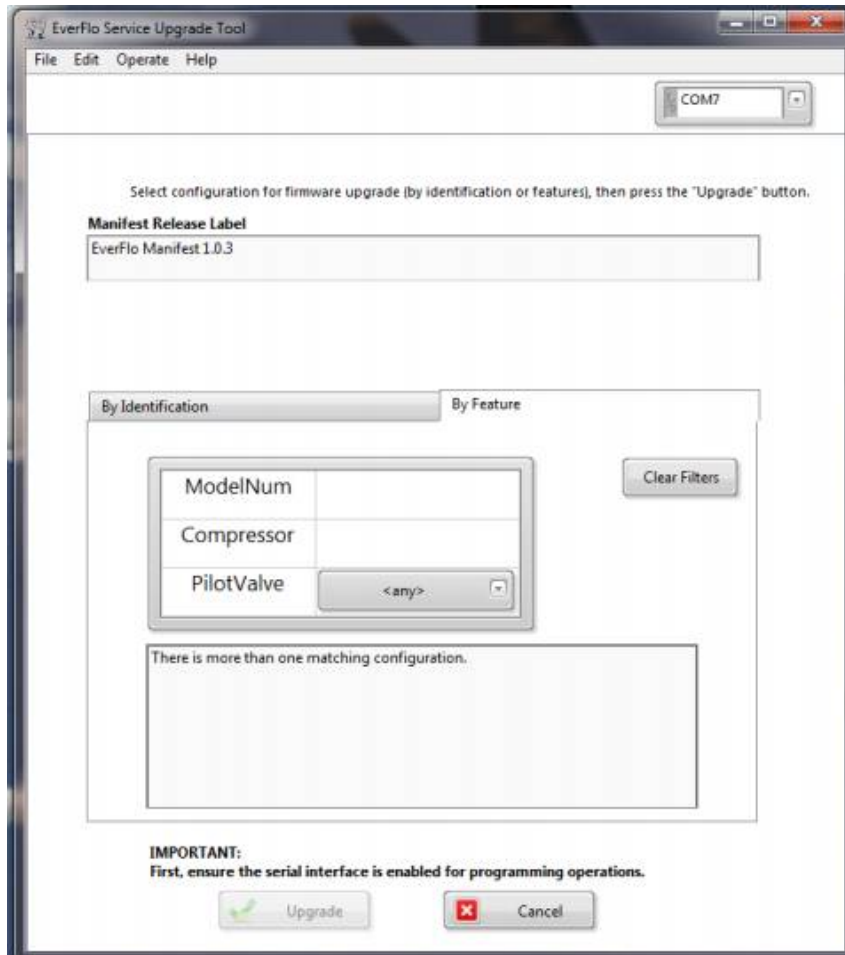

20. Once the firmware is upgraded retest the unit for the customer complaint.
21. If the unit passes, then continue with the repair process and final test.
22. When all the features match, a single known configuration will show in the bottom box.  
If not, the following message appears “There are no matching configurations” and the device needs to be reevaluated as to its original equipment configuration.
23. Click the *Upgrade* button and then proceed with Steps 13 thru 17.

Feature	Definition
By Feature:	Select the model number, compressor type (.44 or .38) and solenoid type (Air or O2 pilot)
Clear Filters:	Allows you to clear the By Features section
Cancel Button:	Cancel Button stops the firmware upgrade operation.
MSP version:	MSP version of the firmware installed.